

Letters to the Editor

J Med Genet 2000;37:785–787

The mutation spectrum in Holt-Oram syndrome

EDITOR—Holt-Oram syndrome (HOS) is a developmental disorder characterised by malformations of the radial ray of the forelimb and by congenital heart disease.¹ The syndrome shows a marked variability in phenotype, with radial ray defects ranging from minor thumb abnormality through to severe reduction defect or phocomelia. The cardiac manifestations of HOS are similarly varied, and patients can present with a variety of structural heart abnormalities, atrial septal defects (ASDs) and ventricular septal defects (VSDs) being the most common, or conduction defects evident on ECG profiles. Previous studies have shown no correlation between the severity of a patient's cardiac and skeletal abnormalities.² Intrafamilial variation can be wide.

HOS shows autosomal dominant inheritance and mutations in the T box transcription factor gene (*TBX5*) have been shown previously to be responsible for this disorder.^{3,4} There is also evidence for genetic heterogeneity.⁵ The mechanism by which mutations in *TBX5* cause a dominant phenotype is not understood at present, and it is anticipated that knowledge of the type of mutations causing HOS may shed light on this. Knowledge of a large number of mutations and the relation of a person's genotype to phenotype is also useful for genetic counselling. In the face of a growing demand for a molecular diagnostic test for HOS, it is also helpful to have a quantitative estimate of the ability of current methods to detect mutations in *TBX5*.

Twenty five cases with a clinical diagnosis of Holt-Oram syndrome have been tested for this study, bringing to 47 the total number of cases studied by us. Minimal diagnostic criteria were as described previously²: bilateral radial ray defect, plus either cardiac abnormality or family history of cardiac abnormality. Cases were referred by a variety of clinicians and underwent full clinical assessment including x ray, electrocardiography (ECG), and echocardiography. Information regarding the clinical features of these patients came from the referring doctor. The patients represented both sporadic (8) and familial (17) cases of Holt-Oram syndrome.

Mutational analysis was carried out using SSCP methods initially, followed by fluorescence sequencing of exons showing a non-standard SSCP banding pattern. The methods used were described in Li *et al.*³ Since that study, further analysis of the genomic structure of *TBX5* has recognised that the previously reported exon B is in fact two exons. Extensive resequencing of both genomic and cDNA forms of *TBX5* has also been undertaken, leading to revisions in the previously reported *TBX5* sequence (the new sequence has accession number AF221714). This sequence is the same across the coding region as that

produced by others.⁶ Of 17 new familial cases tested, eight showed linkage to chromosome 12 and the other families were too small to assess linkage. Table 1 shows that five mutations were identified in familial cases. Only one of these families was sufficiently large to show meaningful linkage to chromosome 12q markers. Of eight new sporadic cases studied, three have yielded mutations. Thus, in the 34 familial cases studied by us, eight mutations have been identified, and six mutations have been identified in 13 sporadic cases. The precise natures of all the new mutations identified are detailed in table 2.

The clinical features of HOS in all 47 cases are consistent with the previously described phenotype² and show the wide spectrum of cardiac and skeletal abnormalities in this syndrome (see Bruneau *et al* for details of the complexity of cardiac abnormalities in HOS patients). Most patients show at least one defect of cardiac septation (an atrial or ventricular septal defect, or atrioventricular block) and abnormalities of the thumb. Radial hypoplasias and aplasias are present in sporadic cases PpHs, H20s, H22s, and H16s and in the familial cases H6f and Ghf, although not in every affected member.

Twenty five non-translocation mutations have been reported, including those presented here. These mutations are of 19 distinct types, with six mutations being identical to previously described forms identified in unrelated subjects (this paper and Basson *et al*). Of the 19 distinct non-translocation, disease causing mutations in *TBX5* currently known, five are truncations, five amino acid substitutions, three splice site changes, and six reading frame shifts.

We have observed a significant difference in the proportion of cases in which a mutation was detected in our group of sporadic cases as opposed to our group of familial cases. Forty six percent (6/13) of sporadic cases studied in our laboratory have yielded mutations by SSCP screening, whereas only 24% (8/34) of familial cases have done so.

The overall mutation detection rate of 30% may be low for a variety of reasons. An inadequate mutation detection method would explain these results, yet the system in use by us is a standard one used on a variety of projects, all of which produce detection rates nearer the theoretical level for these techniques (approximately 95%). The largest PCR product used in the present analysis is only 326 bp long, well within the size acceptable for this kind of analysis. Mutation detection is also fully repeatable in our hands.

There are four other possible explanations for this low mutation detection rate: (1) clinical misdiagnosis in our patients, (2) genetic heterogeneity of Holt-Oram syndrome,⁵ (3) the presence of mutations in the untranslated and promoter regions of *TBX5*, which have not been tested in this analysis, and (4) deletion of whole exons of *TBX5*, which would not be recognised by SSCP.

Table 1 Cases studied

	This study	All studies in our lab
Familial cases studied	17	34
Sporadic cases studied	8	13
Mutations found in familial cases	5	8
Mutations found in sporadic cases	3	6

Table 2 New mutations identified

Case	Mutation type	Location	Mutation form	Result
Nef	Substitution	Intron 4-5	5' splice site(T to C)	Splice site change
Fif	Substitution	Exon 5	nt1170(G to A)	Gly to Arg
FR9f	Substitution	Exon 8	nt1611(G to T)	Stop codon TAG
Jonf	Substitution	Exon 6	nt1233(G to T)	Stop codon TAA
Chas	Substitution	Exon 7	nt1420(G to T)	Ser to Ile
Bers	Deletion	Exon 8	nt1470(del T)	Reading frameshift
PpHs	Substitution	Exon 8	nt1500(C to T)	Stop codon TGA
Ghf	Substitution	Exon 8	nt1500(C to T)	Stop codon TGA

Codes ending in f are familial cases, those with s are sporadic.

Table 3 Clinical phenotypes

Family	Pedigree No	Mutation	Skeletal abnormality	Cardiac abnormality
H8f	I.1	Exon 8 nt1500 C→T	Bilateral hypoplastic thumbs Syndactyly 1/2	AV block
	II.2		Right triphalangeal thumb Left absent thumb Bilateral radial hypoplasia	ASD
H12f	I.1	Exon 8 nt1500 C→T	Bilateral hypoplastic thumbs Syndactyly 1/2	AV block
	II.1		Bilateral hypoplastic thumbs Syndactyly 1/2	AV block
	II.3		Absent thumbs Bilateral radial hypoplasia	VSD
H22s		Exon 8 nt1500 C→T	Bilateral triphalangeal thumbs Bilateral radial hypoplasia	ASD
PpHs		Exon 8 nt1500 C→T	Bilateral absent thumbs Left radial aplasia	AV block
			Right radial hypoplasia	
Ghf		Exon 8 nt1500 C→T	Bilateral absent thumbs Right radial aplasia	ASD
			Left radial hypoplasia	

Other studies of HOS have not published mutation detection rates. We can only speculate as to why the rate of mutation detection in sporadic cases should be higher than that in familial cases (particularly in those familial cases whose disease loci are known to be present on 12q). An obvious explanation for such a discrepancy is ascertainment bias. A sporadic case must have both detectable heart and limb symptoms to be diagnosed as having HOS, whereas a family need only show both these effects across the pedigree (rather than in one subject) along with an autosomal dominant inheritance pattern.

A group of five of the 25 mutations published so far are the same, a C to T transition at position 1500, generating a stop codon. This mutation is seen in both sporadic and familial HOS cases among patients who do not share common alleles at microsatellite loci closely linked to *TBX5*. This site is likely to represent, therefore, a true "mutation hotspot". The residue is part of a CG duplet, and therefore is likely to be methylated, with a high frequency of mutation to a thymine residue. Studies across a variety of human diseases have found distributions of mutations skewed towards the mutation of CpG sites. The retinoblastoma gene, *RB1*, shows a distribution of mutations severely skewed towards a few C→T transition hotspots (see the *RB1* mutation database⁸ for details).

Basson *et al*⁶ argue, based on a collection of HOS families of varying symptom severity, that there is a relationship between the phenotype of patients and their specific mutation. It is proposed that truncation mutations in *TBX5* lead to both limb and cardiac malformation, whereas single amino acid changes have different effects depending on their position in the T box. The set of HOS cases we have examined contains no large families of the type studied in this earlier analysis.

The five known cases (two familial and three sporadic) with the same mutation, a C→T transition at nucleotide 1500 in exon 8, present an opportunity to examine more closely the possibility of mutation specific genotype-phenotype correlation in cases with a truncation in *TBX5*. The clinical phenotypes of these cases are presented in table 3. Cardiac defects presented include isolated ASD and isolated VSD but no case with this mutation has a complex cardiac lesion. Syndactyly of the thumb and first finger is common within this group. There is much variation in symptom severity and the group as a whole shows no bias towards a particular severity of either cardiac or skeletal symptoms, in agreement with Basson *et al*.⁶

Along with the truncation forms already described, we have identified two new mutations which each result in a single amino acid substitution. The change in family Fif inserts an arginine in place of a glycine at position 169,

which is conserved across T box genes such as *Xbra* (*Xenopus*), *T* (mouse), *TbxT* (chick), and *omb* (*Drosophila*).⁹ This introduces a strongly basic residue into a non-polar region in the DNA binding T domain. Family Fif comprises eight affected subjects in two generations, who show significant cardiac involvement compared with very mild skeletal findings. One case has a complex lesion, ASD with VSD, and another case has pulmonary stenosis, a conotruncal malformation which is not typical in HOS. This is consistent with a role for *TBX5* which extends beyond cardiac septation.¹⁰ Only one subject in family Fif has a demonstrable limb abnormality and this is stiffening of the thumbs. The phenotype of this family is therefore consistent with the suggestion that substitution mutations produce predominantly limb or predominantly cardiac features, depending upon their location within *TBX5*.⁶

The change of a serine to an isoleucine in patient Chas is outside the T domain of the protein and its biochemical effects are not known. The phenotype of this patient included a spinal scoliosis, which has not previously been observed in Holt-Oram syndrome, together with bilateral hypoplastic thumbs, syndactyly, and a ventricular septal defect. Currently available details on expression of *TBX5* during development of the mouse and chick give no evidence of expression in the developing spine which would account for such a phenotype being the result of mutation of *TBX5*.^{12 13}

In summary, these new data expand our knowledge of the spectrum of mutations that cause Holt-Oram syndrome and also raise interesting questions about the genetic heterogeneity of this disease and its mutations. Clearly there is a need to improve the frequency of mutation detection in HOS and current analysis of untranslated and promoter regions, and screens for whole exon deletions should prove useful. A diagnostic service for *TBX5* mutations is being set up.¹³

The first three authors contributed equally to this work. This work was funded by the British Heart Foundation. Ethical approval for the study was obtained from the Nottingham City Hospital Research Ethics Committee.

STEPHEN J CROSS*
YUNG-HAO CHING*
QUAN YI LI*¥
LINDSAY ARMSTRONG-BUISSERET*
STEPHANIE SPRANGER†
STANISLAW LYONNET‡
DAMIEN BONNET§
MAILA PENTTINEN¶
PHILIPPE JONVEAUX**
BRUNO LEHEUP††
GEERT MORTIER‡‡
CONNY VAN RAVENSWAAL§§
CAROL-ANNE GARDINER¶¶
J DAVID BROOK*
RUTH NEWBURY-ECOB***

*Institute of Genetics, University of Nottingham, Queen's Medical Centre, Nottingham NG7 2UH, UK

†Centre of Human Genetics and Genetic Counseling, University of Bremen, Leobener Street, D-28359 Bremen, Germany

‡Unité de Recherches sur les Handicaps Génétiques de l'Enfant, Groupe Hospitalier Necker-Enfants Malades, 149 Rue de Sevres, 75743 Paris Cedex 15, France

§Service de Cardiologie Pédiatrique, Groupe Hospitalier Necker-Enfants Malades, 149 Rue de Sevres, 75743 PARIS Cedex 15, France

¶Turku University Central Hospital, Clinical Genetics Unit, PL 52, 20521 Turku, Finland

**Service de Génétique, Centre Hospitalier, Universitaire de Nancy, rue du Morvan, 54511 Vandoeuvre les Nancy, France

††Médecine Infantile et Génétique Clinique, Hôpital d'Enfants, Centre Hospitalier Universitaire de Nancy, rue du Morvan, 54511 Vandoeuvre les Nancy, France

‡‡Department of Medical Genetics, University Hospital Gent, De Pintelaan 185, B-9000 Gent, Belgium

§§Department of Human Genetics, University Hospital Nijmegen, PO Box 9101, 6500 HB Nijmegen, The Netherlands

¶¶Yorkshire Regional Genetic Service, Department of Clinical Genetics, St James's University Hospital, Ashley Wing, Beckett Street, Leeds LS9 7TF, UK

***Clinical Genetic Service, Institute of Child Health, Bristol Royal Hospital for Sick Children, St Michael's Hill, Bristol BS2 8B7, UK

Correspondence to: Professor Brook, David.Brook@nottingham.ac.uk

¥Present address: Department of Pediatric Cardiology, The Children's Hospital of Philadelphia, Philadelphia, PA 19104, USA

- Holt M, Oram S. Familial heart disease with skeletal malformations. *Br Heart J* 1960;22:236-42.
- Newbury-Ecob R, Leanage R, Raeburn JA, Young ID. The Holt-Oram syndrome: a clinical genetic study. *J Med Genet* 1996;33:300-7.
- Li QY, Newbury-Ecob RA, Terrett JA, Wilson DI, Curtis ARJ, Yi CH, Gebuhr T, Bullen PJ, Robson SC, Strachan T, Bonnet D, Lyonnet S, Young ID, Raeburn JA, Buckler AJ, Law DJ, Brook JD. Holt-Oram syndrome is caused by mutations in *TBX5*, a member of the *Brachyury(T)* gene. *Nat Genet* 1997;15:21-9.
- Basson CT, Bachinsky DR, Lin RC, Levi T, Elkins JA, Soultz J, Grayzel D, Kroumpouzou E, Traill TA, Leblanc-Straceski J, Renault B, Kucherlapati R, Seidman JG, Seidman CE. Mutations in human *TBX5* cause limb and cardiac malformation in Holt-Oram syndrome. *Nat Genet* 1997;15:30-5.
- Terrett JA, Newbury-Ecob R, Cross GS, Fenton I, Raeburn JA, Young ID, Brook JD. Holt-Oram syndrome is a genetically heterogeneous disease with one locus mapping to human chromosome 12q. *Nat Genet* 1994;6:401-4.
- Basson CT, Huang T, Lin RC, Bachinsky DR, Weremowicz S, Vaglio A, Bruzzone R, Quadrelli R, Lerone M, Romeo G, Silengo M, Pereira A, Krieger J, Mesquita SF, Kamisago M, Morton CC, Pierpont MEM, Muller CW, Seidman JG, Seidman CE. Different *TBX5* interactions in heart and limb defined by Holt-Oram syndrome mutations. *Proc Natl Acad Sci USA* 1999;96:2919-24.
- Bruneau BG, Logan M, Davis N, Levi T, Tabin CJ, Seidman JG, Seidman CE. Chamber-specific cardiac expression of *Tbx5* and heart defects in Holt-Oram syndrome. *Dev Biol* 1999;211:100-8.
- <http://www.d-lohmann.de/Rb>
- Muller CW, Herrmann BG. Crystallographic structure of the T domain - DNA complex of the Brachyury transcription factor. *Nature* 1997;389:884-8.
- Horb ME, Thomsen GH. *Tbx5* is essential for heart development. *Development* 1999;126:1739-51.
- Chapman DL, Garvey N, Hancock S, Alexiou M, Agulnik S, Gibson-Brown JJ, Cebra-Thomas J, Bollag RJ, Silver LM, Papaioannou VE. Expression of the T-box family genes, *Tbx1-Tbx5*, during early mouse development. *Dev Dynamics* 1996;206:379-90.
- Gibson-Brown JJ, Agulnik SI, Silver LM, Papaioannou VE. Expression of T-box genes *Tbx2-Tbx5* during chick organogenesis. *Mech Dev* 1998;74:165-9.
- Contact Dr Gareth Cross; gcross@ncht.org.uk

J Med Genet 2000;37:787-789

Hemiplegic cerebral palsy and the factor V Leiden mutation

EDITOR—Two mutations have been identified in recent years that predispose a heterozygous carrier to venous thrombosis. One is a mutation localised to the factor V gene, Arg 506 to Gln (factor V Leiden mutation, *FVL*), which has been shown to be the most common cause of familial thrombosis^{1,2} through resistance to activated protein C (APC), which is an inhibitor of activated factors V and VIII.³ The second is in the gene for the coagulation factor prothrombin (factor II), the G20210A mutation.⁴

There are two published estimates of prevalence of the *FVL* mutation in the Australian population, the first in a study of recurrent miscarriage,⁵ where 3.5% of the controls had *FVL*. The other is a recent study of blood donors where 3.6% were found to be heterozygous.⁶

Fewer studies have been done on the prothrombin (*PT*) mutation which is not as prevalent, thought to occur in approximately 2% of healthy, normal controls.^{1,4}

Of particular relevance to this study are the findings of children with ischaemic strokes⁷⁻⁹ or thromboembolism,^{10,11} who have been reported as having a high prevalence of the *FVL* mutation. A more recent study¹² suggests that neither *FVL* nor *PT* is a risk factor for childhood stroke and that "a large prospective multicentre study is required" to investigate this further. There has also been a report of three babies with hemiplegic cerebral palsy (CP) who were heterozygous for the *FVL* mutation.¹³ In the three cases, there was a suggestion that placental infarction/thrombosis or neonatal stroke may have occurred and resulted in the hemiplegia. Other relevant studies have also been done, suggesting that placental infarction and late fetal loss^{14,15} may occur more frequently in women who are carriers of *FVL*.

Cerebral palsy (CP) is a common physical disability in childhood occurring in 2.0-2.5 per 1000 live births. In a sig-

nificant proportion, no cause can be established. Current research suggests that between 6 and 8% of cases are the result of birth asphyxia¹⁶⁻¹⁸ and postnatal problems account for a further 10%.^{19,20} Prenatal events are now thought to be responsible for approximately 75% of all cases of cerebral palsy, although it is usually impossible to determine the nature and exact timing of the damaging event. Given the lifetime impact that cerebral palsy has on the person and the family, a search for further causative factors is essential, as new information regarding aetiology may provide the first step to instituting preventive strategies.

In Victoria, there is a CP Register containing demographic and clinical details of 2093 babies born between 1970 and 1995. A letter was sent to the parents of 69 selected patients requesting permission to access the blood spot collected routinely at birth (Guthrie card) for newborn screening purposes. These 69 were chosen because they were private patients of one of the authors (DR) and could therefore be approached directly. The identifiable blood spots are held at The Murdoch Children's Research Institute and are not available for research or other purposes unless permission is obtained from the parents. All had a diagnosis of cerebral palsy with a specific motor diagnosis of spastic hemiplegia.

We estimated that a sample size of 50 would detect a significant increase in prevalence of the *FVL* mutation from a background prevalence of 4% to one of 15%, with a power of 80% and alpha of 0.05.

Two 3 mm² sections of Guthrie blood spots were cut out and placed in 50 µl of PCR buffer. They were initially incubated at 95°C for 30 minutes, then kept at 37°C overnight, after which they were pulse centrifuged. The supernatant was then transferred to a sterile 500 µl tube and kept at 4°C until the day of analysis.

DNA encompassing the *FVL* codon 506 mutation was amplified by PCR. The resulting product was checked on a 1% agarose gel stained with ethidium bromide before restriction enzyme digestion. DNA was digested overnight at 37°C using the enzyme *MnII*. Fragments were then

Table 1 Radiological findings

Radiology	Normal	Evidence of ischaemic lesion	Hydrocephalus	PFVL	IVH	Non-specific lesion	Total
Ultrasound	3	—	3	1	2	1	10
CT scan	1	10 (2)	2	1	—	3 (2)	17
MRI	—	4 (1)	1	1	—	—	6
Not available/not done							22

Number in brackets refers to number of patients with mutation.
PFVL: periventricular leucomalacia.
IVH: intraventricular haemorrhage.

separated on a 6% polyacrylamide gel and subsequently stained with ethidium bromide. Both normal and heterozygote samples were run as controls in each assay.

The same methodology was applied for detection of the prothrombin 20210 polymorphism, but with *HindIII* restriction enzyme used, and with digest fragments being separated on a 3% agarose gel.

Power calculations were done in SPSS for Windows, version 8.0, SAMPLE POWER, and the binomial comparison of the sample prevalence with the estimated population prevalence was also done in SPSS version 8.0.

Of the 69 parents contacted, 58 responded (84%). All gave permission for use of the blood spot, except for one where the child was in the care of foster parents who did not feel that it was appropriate to give consent. Two Guthrie cards were unable to be found leaving a sample of 55 cases.

Of the 55 subjects recruited, 54 and 52 could be amplified successfully for the *FVL* and *PT* mutations, respectively. Of the 54 samples screened for *FVL*, one was found to be homozygous while three were found to be heterozygous. Therefore, the frequency of cases with at least one mutation of *FVL* was 7.4% which does not differ significantly from the average Australian population heterozygote prevalence of 3.6% (binomial test, one tailed p value=0.13). Only one of the 52 samples analysed for *PT* was found to be heterozygous (1.9%).

The clinical features of the five subjects with positive findings are as follows.

(1) Homozygous for *FVL* mutation. This child was born by caesarean section at 32 weeks following a pregnancy complicated by pre-eclamptic toxemia. His birth weight was 1815 g. Hemiplegic cerebral palsy was diagnosed at the age of 4 months. A CT brain scan showed appearances consistent with infarction. There was no family history of note but testing showed that his mother is a heterozygote for *FVL*.

(2) Heterozygous for *FVL* mutation. These three children were all normal birth weight, term infants. One child required some resuscitation at birth and meconium had been passed before delivery. Her MRI showed middle and anterior cerebral atrophy infarction. The family history was unremarkable apart from the unexpected death of the paternal grandfather, from a myocardial infarct, at 50 years of age. The other two children had uneventful perinatal periods and hemiplegia became apparent during the first year of life. Both had CT scans which showed loss of cerebral hemisphere substance in both grey and white matter with enlarged ventricles, not necessarily typical of major vessel infarction. While one child had a negative family history, the other child's grandmother had sustained a deep venous thrombosis following a hysterectomy at the age of 50 years.

(3) Heterozygous for the prothrombin mutation. This child had an uneventful perinatal period. A diagnosis of hemiplegic cerebral palsy was made at the age of 8 months. A CT brain scan showed signs of infarction with almost complete absence of the left frontal temporal and parietal lobes, with appearances typical of congenital occlusion of the left anterior and middle cerebral arteries and subsequent prencephaly. There was no family history of note.

All available radiological findings were assessed and are summarised in table 1.

If only cases with radiological evidence of ischaemia (14 cases) are used in the calculations, the frequency of either of the thrombophilia mutations (three cases) is 21%. This is significantly higher than the population prevalence (binomial test, one tailed p value=0.013).

In summary, evidence of the influence of the *FVL* mutation on thrombosis led us to consider whether a significant attributable factor to CP may be the presence of this mutation, which could cause an adverse vascular event such as placental infarcts or stroke in utero or early in postnatal life. To test this hypothesis, we obtained the frequency of the mutation in blood spots from a sample of children, all of whom had hemiplegic CP. This group was chosen because it was thought to be relatively homogeneous and it seemed that if a vascular event were causative, then spastic hemiplegia could be the most likely outcome. However, an examination of their radiological findings, after the mutation detection had been undertaken, showed quite marked heterogeneity. It was among the 14 cases with a known ischaemic event that three mutations were found, giving a significantly higher prevalence of 21%.

From these results, we conclude that there may be a relationship between carrier status for mutations predisposing an infant to thrombophilia and cerebral vascular events in utero (or neonatally) that lead to CP. To confirm such a relationship it will be necessary to study a larger sample of CP patients with a vascular basis, such as venous or arterial occlusion, and compare mutation frequencies with children with CP who do not have a vascular basis for CP.

In addition, investigation of maternal mutation status would be useful, particularly because the frequency of maternal pre-eclampsia in this sample was higher than expected (data not shown), 11% compared with the reported population frequency of approximately 5%^{21, 22} and it is not known whether these mothers had *FVL* or *PT* mutations.

We report our findings at this stage to illustrate how DNA testing for common polymorphisms, which are of unknown importance in the general population, may be of importance to subjects within subgroups of the population. Primarily this would be for clinical management, but perhaps when potentially interactive aetiological factors, such as smoking in pregnancy, are better defined, this genetic information could be used for preventive measures.

We would like to thank Nick Tzanakos in the newborn screening laboratory of the Victorian Clinical Genetics Service, Murdoch Institute, for his technical assistance and Carole Webley for help in preparation of the manuscript.

J L HALLIDAY*
D REDDIHOUGH†
K BYRON‡
H EKERT§
M DITCHFIELD¶

*Epidemiology Unit, The Murdoch Children's Research Institute, Parkville, Victoria 3052, Australia

†Child Development and Rehabilitation, Royal Children's Hospital, Parkville, Victoria, Australia

‡Centre for Medical Research, Royal Melbourne Hospital, Parkville, Victoria, Australia

§Haematology and Oncology, Royal Children's Hospital, Parkville, Victoria, Australia

¶Department of Radiology, Royal Children's Hospital, Parkville, Victoria, Australia

Correspondence to: Dr Halliday, halliday@cryptic.rch.unimelb.edu.au

- Bertina RM, Koelman BP, Koster T, Rosendaal FR, Dirven RJ, Ronde Hd. Mutation in blood coagulation factor V associated with resistance to activated protein C. *Nature* 1994;369:64-7.
- Zoller B, Dahlback B. Linkage between inherited resistance to activated protein C and factor V gene mutation in venous thrombosis. *Lancet* 1994;343:1536-8.
- Dahlback B, Carlsson M, Svensson PJ. Familial thrombophilia due to a previously unrecognized mechanism characterised by poor anticoagulant response to activated protein C: prediction of a cofactor to activated protein C. *Proc Natl Acad Sci USA* 1993;90:1004-8.
- Poort SR, Rosendaal FR, Reitsma PH, Bertina RM. A common genetic variation in the 3'-untranslated region of the prothrombin gene is associated with elevated plasma prothrombin levels and an increase in venous thrombosis. *Blood* 1996;88:3698-703.
- Metz J, Kloss M, O'Malley CJ, Rockman SP, De Rosa L, Doig RG, McGrath KM. Prevalence of factor V Leiden is not increased in women with recurrent miscarriage. *Clin Appl Thromb/Hemo* 1997;3:137-40.
- Pecheniuk NM, Marsh NA, Walsh TP, Dale JL. Use of first nucleotide change technology to determine the frequency of factor V Leiden in a population of Australian blood donors. *Blood Coag Fibrin* 1997;8:491-5.
- Nowak-Gottl U, Strater R, Dubbers A, Oleszuk-Raschke K, Vielhaber H. Ischaemic stroke in infancy and childhood: role of the Arg506 to Gln mutation in the factor V gene. *Blood Coag Fibrin* 1996;7:684-8.
- Ganesan V, Kelsey H, Cookson J, Osborn A, Kirkham FJ. Activated protein C resistance in childhood stroke. *Lancet* 1996;347:260.
- Zenz W, Bodo Z, Plotho J, Streif W, Male Ch, Bernert G, Rauter L, Ebetsberger G, Kaltenbrunner K, Kurnik P, Lischka A, Paky F, Ploier R, Hofler G, Mannhalter C, Muntean W. Factor V Leiden and prothrombin gene G 20210 a variant in children with ischemic stroke. *Thromb Haemostas* 1998;80:763-6.
- Aschka I, Aumann V, Bergmann F, Budde E, Eberl W, Eckhof-Donovan S, Krey S, Nowak-Gottl U, Schobess R, Sutor AH, Wendisch J, Schneppenheimer R. Prevalence of factor V Leiden in children with thrombo-embolism. *Eur J Pediatr* 1996;155:1009-14.
- Vielhaber H, Ehrenforth S, Koch H, Scharer J, Werf Nvd, Nowak-Gottl U. Cerebral venous sinus thrombosis in infancy and childhood: role of genetic and acquired risk factors of thrombophilia. *Eur J Pediatr* 1998;157:555-60.
- McCull MD, Chalmers EA, Thomas A, Sproul A, Healey C, Rafferty I, McWilliam R, Eunson P. Factor V Leiden, prothrombin 20210 G→A and the MTHFR C677T mutations in childhood stroke. *Thromb Haemostas* 1999;81:690-4.
- Thorarensen O, Ryan S, Hunter J, Younkin DP. Factor V Leiden mutation: an unrecognized cause of hemiplegic cerebral palsy, neonatal stroke and placental thrombosis. *Ann Neurol* 1997;42:372-5.
- Rai R, Regan L, Hadley E, Dave M, Cohen H. Second-trimester pregnancy loss with activated protein C resistance. *Br J Haematol* 1996;92:489-90.
- Grandone E, Margaglione M, Colaizzo D, d'Addidda M, Cappucci G, Vecchione G, Sciannone N, Pavone G, Di Minno G. Factor V Leiden is associated with repeated and recurrent unexplained fetal losses. *Thromb Haemostas* 1997;77:822-4.
- Blair E, Stanley F. Intrapartum asphyxia: a rare cause of cerebral palsy. *J Pediatr* 1988;112:515-19.
- Naeve RL, Peters EC, Bartholomew M, Landis JR. Origins of cerebral palsy. *Am J Dis Child* 1989;143:1154-61.
- Yudkin PL, Johnson A, Clover LM, Murphy KW. Assessing the contribution of birth asphyxia to cerebral palsy in term singletons. *Paediatr Perinat Epidemiol* 1995;9:156-70.
- Holm VA. The causes of cerebral palsy. A contemporary perspective. *JAMA* 1982;247:1473-7.
- Pharoah P, Cooke T, Rosenbloom L. Acquired cerebral palsy. *Arch Dis Child* 1989;64:1013-16.
- Dizon-Townson DS, Nelson LM, Easton K, Ward K. The factor V Leiden mutation may predispose women to severe preeclampsia. *Am J Obstet Gynecol* 1996;175:902-5.
- Ros HS, Cnattingius S, Lipworth L. Comparison of risk factors for preeclampsia and gestational hypertension in a population-based cohort study. *Am J Epidemiol* 1998;147:1062-70.

J Med Genet 2000;37:789-791

Analysis of the human tumour necrosis factor-alpha (TNF α) gene promoter polymorphisms in children with bone cancer

EDITOR—TNF α (tumour necrosis factor-alpha) is a cytokine produced by macrophages and monocytes with a wide range of activities, and polymorphisms within this gene have been postulated to contribute to MHC associations with autoimmune and infectious diseases.¹ The role of TNF α in cancer is a controversial matter, because while it plays a key role in the "in vitro" killing of tumour cells by macrophages and lymphocytes, it has also been found in high concentrations in patients with cancer, suggesting that it may be an endogenous tumour promoter "in vivo".^{2,3} Different results with several tumour types show that TNF α may have both tumour necrotic and tumour promoting activities.

Recently, several genetic polymorphisms have been described in the human TNF α promoter.⁴⁻⁶ Among them, the rare allele at position -308 (TNF308.2) has been proven to be part of a complex haplotype that is involved in higher TNF α levels and has been related to poor prognosis in several diseases.⁷ The existence of different TNF α alleles, related to different levels of TNF α , raises the possibility that tumour development is somewhat related to the genetic propensity of the person to produce higher levels of TNF α and, therefore, with the presence of genetic variants in this gene. In fact, an increase in the TNF308.1/TNF308.2 genotype has been reported in different tumour types, with a significantly increased frequency of the TNF308.2 allele in patients with malignant tumours.⁸ Wilson *et al* have shown that the polymorphism at -308 has a significant effect on the transcriptional activity of the human TNF α gene, either because the interaction of the transcription enhancers is increased owing to the different

DNA conformations, or because the TNF2 variant is the target for novel binding proteins.

The G to A transition at position -238 (TNF238.2) is also suspected to influence the expression of TNF α , and although its clinical and functional consequences are not clear so far,⁹ it has been associated with development and prognosis of different diseases as well.^{10,11}

The effects of TNF α on osteoblast differentiation and proliferation are complex but it is generally assumed that it inhibits bone formation and stimulates bone resorption.¹² The activity of TNF α in osteosarcoma, Ewing's sarcoma, and primary human osteoblast cultures has been widely studied showing that it has an antiproliferative and cytotoxic role which usually depends on the type of cell line under analysis.^{13,14}

Synergistic cytotoxicity has been described between TNF α and other cytokines, most frequently IFN γ (interferon gamma) and also with certain drugs that are commonly used in the treatment of osteosarcoma and Ewing's sarcoma like the topoisomerase II inhibitors.¹⁵ The data available indicate that TNF α and agents that stimulate its production by host macrophages may have a role in the treatment of osteosarcoma and Ewing's sarcoma.

Based on the role of TNF α in bone biology and the growing evidence of the relationship existing between TNF α genetics and cancer, we tried to test the hypothesis of whether genetic polymorphisms of the TNF α promoter contribute to the pathogenesis or prognosis of paediatric bone tumours.

DNA was extracted following standard procedures¹⁵ from peripheral blood lymphocytes of 110 paediatric patients (52 females, 58 males) with bone tumours (63 osteosarcomas and 47 Ewing's sarcomas) and 111 healthy children (53 females, 58 males). All the subjects included in the analysis were white, most of them from the region of Navarre (Spain), and the age distribution was very similar in the tumour and control groups (mean (SD): osteosarcoma 13.5 years (SD 3.3), Ewing's sarcoma 12 years (SD 3.7), controls 11.1 years (SD 5.1)).

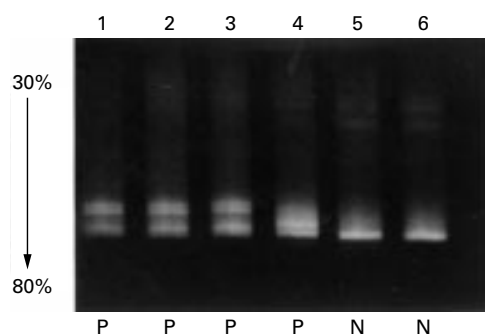

Figure 1 DGGE gel showing polymorphic and normal band patterns. Lanes 1 to 3: genotype normal/-376-238. Lane 4: genotype normal/-308. Lanes 5 and 6: normal, non-polymorphic patterns.

Table 1 Genotypes for the *TNF α* gene promoter in the control subjects and the bone tumour groups

Genotypes	Controls (n=111)*		Osteosarcoma (n=63)		ES† (n=47)	
	No	%	No	%	No	%
Normal/normal	67	60.4	47	74.6	35	74.5
Normal/-308	26	23.4	13	20.6	6	12.8
Normal/-238-376	11	9.9	2	3.2	4	8.5
-308/-238-376	2	1.8	0	0	0	0
Normal/-238	5	4.5	0	0	2	4.3
-308/-308	0	0	1	1.6	0	0

*Number of subjects analysed.

†ES, Ewing's sarcoma.

The human *TNF α* promoter region between nucleotides -398 and -103 was analysed by PCR-DGGE (polymerase chain reaction coupled to denaturing gradient gel electrophoresis) as previously published^{16, 17} (fig 1).

Statistical analyses were performed with the Statistical Package for the Social Sciences (SPSS, version 9.0). The chi-square contingency test, with Yates's modification for small numbers if needed, was used to test for a significant association between disease and *TNF α* genotypes or haplotypes. Crude odds ratios (ORs) were calculated and given with 95% confidence intervals (CI). To test for association between clinical parameters and genotypes or haplotypes, *t* tests or one way analysis of variance (ANOVA) were performed. Statistical significance was assumed if $p \leq 0.05$ and highly statistical difference if $p < 0.01$; differences between variables with $p > 0.05$ were considered not statistically different. Osteosarcomas and Ewing's sarcomas were treated independently in the statistical analyses given that they are different clinical entities, both in genetic background and in the clinical and histological aspects.

We have analysed the distribution of the *TNF α* gene promoter polymorphisms at positions -376, -308, -238, and -163 in 110 bone sarcoma paediatric patients and in

111 paired healthy children, to search for the putative association between the *TNF α* gene and tumour development or prognosis.

The overall distribution of *TNF α* polymorphic alleles in bone cancer paediatric patients and control subjects is shown in table 1. As in previous reports, polymorphisms at -376 and -238 were found to be in linkage disequilibrium.⁵ To date, there are no consistent data on the frequency of the polymorphic alleles at -376 and -163 in white populations, and larger series should be screened to establish the frequencies for these alleles in both normal and disease related populations.

The frequencies of the alleles at -308 and -238 in the Spanish population (0.87 and 0.92, respectively, deduced from table 2) were found to be very similar to those described for European white populations.^{10, 18}

Tables 2 and 3 show the allele and genotype frequencies of the genetic variants of the *TNF α* gene promoter at -308 and -238 in both cancer patients and healthy subjects. The frequency of the TNF238.2 allele (adenine at position -238) and TNF238.1/TNF238.2 heterozygote genotype was significantly lower in the osteosarcoma group, but not among Ewing's sarcomas. We did not find any outstanding difference in the distribution of the TNF308.2 allele (adenine at position -308) between bone sarcomas and controls.

No relationship was found between the presence of genotypes for the *TNF α* gene promoter and any of the clinical parameters tested: tumour stage, tumour location or size, development of metastasis or relapse, and age at diagnosis (data not shown).

Surprisingly, the percentage of males carrying polymorphisms of the *TNF α* promoter was statistically higher than in females ($p=0.025$, OR=4.05, CI=1.13-14.43). We did not detect this difference in the group of healthy controls, in which the distribution of polymorphic patterns was similar in both sexes.

Several reports have indicated that different HLA (human leucocyte antigen) products and related genes may be risk factors for and also protective factors against cancer. The *TNF α* gene is of particular interest because of its involvement in tumour immunity and cancer pathogenesis and the relationship existing between certain *TNF α* genetic variants and human tumours.

Although the exact regulatory mechanisms altered by the *TNF α* promoter polymorphisms are not completely delineated, studies on these polymorphisms have shown that those at -308 and -238 are associated with the development and even prognosis of certain types of cancer. Chouchane *et al*⁶ detected a marked decrease of the TNF308.1 homozygous genotype in patients with non-Hodgkin's lymphoma, breast carcinoma, and in a group of different malignant tumours. Nevertheless, it must be taken into account that the results of this study were obtained with

Table 2 Frequencies of the *TNF α* promoter alleles -238 and -308 in the paediatric bone sarcoma groups compared to control children

Allele	Controls (n=222)*		Osteosarcoma (n=126)		ES† (n=94)	
	No	%	No	%	No	%
<i>Locus TNFα -308</i>						
G (TNF308.1)	194	87.4	111	88.1	88	93.6
A (TNF308.2)	28	12.6	15	11.9	6	6.4
			p=0.847, NS, OR=0.94 (CI 0.48, 1.83)		p=0.102, NS, OR=0.47 (CI 0.19, 1.18)	
<i>Locus TNFα -238</i>						
G (TNF238.1)	204	91.9	124	98.4	88	93.6
A (TNF238.2)	18	8.1	2	1.6	6	6.4
			p=0.012, ‡, OR=0.18 (CI 0.042, 0.8)		p=0.6, NS, OR=0.77 (CI 0.29, 2.01)	

*Number of alleles analysed.

†ES, Ewing's sarcoma.

‡Statistically significant.

Table 3 Genotypes for the TNF α promoter variants at -238 and -308 in bone sarcoma patients and in healthy controls

Genotype	Controls (n=111)*		Osteosarcoma (n=63)		ES† (n=47)	
	No	%	No	%	No	%
<i>Locus TNFα -308‡</i>						
GG	83	74.8	49	77.8	41	87.2
GA	28	25.2	14§	22.2	6	12.8
			p=0.65, NS, OR=0.85 (CI 0.41, 1.76)		p=0.08, NS, OR=0.43 (CI 0.17, 1.13)	
<i>Locus TNFα -238</i>						
GG	93	83.8	61	96.8	41	87.2
GA	18	16.2	2	3.2	6	12.8
			p=0.0095, ¶, OR=0.17 (CI 0.04, 0.76)		p=0.58, NS, OR=0.76 (CI 0.28, 2.04)	

*Number of subjects analysed.

†ES, Ewing's sarcoma.

‡In each polymorphism G is the normal allele and A is the polymorphic one.

§13 patients are GA and one is AA.

¶Statistically significant.

adult patients in the Tunisian population and the polymorphisms of TNF α are dependent on ethnicity.

In the present study, we report a decrease in the TNF238.2 rare allele among osteosarcoma paediatric patients and no difference from the control population in the distribution of the TNF308.2 variant in either of the tumour groups analysed, while other authors have described a decreased representation of the TNF308.2 allele in cancer populations (for example, in chronic lymphocytic leukaemia).¹⁹

Although the exact influence of the TNF238.2 variant on TNF α function and expression is not fully understood to date, the localisation of this polymorphism in the regulatory Y box²⁰ suggests that it may contribute to the optimal function and regulation of the TNF α promoter. However, it has been proven, in transfection assays, that there are no differences in TNF α production after stimulation of TNF238.2 heterozygous or normal homozygous cells; therefore TNF238.2 is not likely to be of functional relevance for transcriptional activation, and the actual meaning of the -238 promoter polymorphism remains a controversial matter.

There is evidence that the -308 TNF2 allele is over-expressed in diseases where TNF α levels are associated with poor prognosis. In our bone sarcoma series, we did not find a relationship between this or any other polymorphic variant of the TNF α promoter and tumour prognosis, disease free survival or development of metastasis or relapse (data not shown). One hypothesis is that these polymorphisms may serve as markers for additional polymorphisms or mutations in neighbouring genes that may be involved in the disease.

With regard to the increased number of TNF α polymorphic alleles in male osteosarcoma patients, several other authors have reported gender differences and increased TNF α levels in male patients affected by type II diabetes mellitus.²¹ A possible explanation for this finding is that the increased plasma levels of TNF α in males are the consequence of the presence of an increased number of the TNF308.2 allele, which has been associated with higher expression of the TNF α gene. In fact, in our series of osteosarcoma, there is a tendency for a higher number of TNF308.2 alleles in male patients, without reaching, however, statistical significance (p=0.079).

Computer DGGE programs Melt87 and SQHTX were kindly provided by Dr L. Lerman. We are also grateful to Dr H. Holden from the Laboratory of Molecular Medicine of the University of Sheffield for providing us with some polymorphic samples and to Dr Reyes López de Mesa for statistical assistance. This work was supported by a PIUNA grant from the University of Navarra.

ANA PATIÑO-GARCÍA*
ELENA SOTILLO-PINEIRO*
CONSUELO MODESTO†
LUIS SIERRASESÚMAGA*

*Laboratory of Paediatrics, University of Navarra and University Clinic, CIFA Building, Irunlarrea SN, E31080 Pamplona, Spain

†Department of Internal Medicine, Hospital Val D'Hebrón, Barcelona, Spain

Correspondence to: Dr Patiño-García, apatigar@unav.es

- Rink L, Kirchner H. Recent progress in the tumor necrosis factor- α field. *Int Arch Allergy Immunol* 1996;111:199-209.
- Roesler K, Suchanek G, Breitschopf H, Kitz K, Matula C, Lassmann H, Koos WT. Detection of tumor necrosis factor- α protein and messenger RNA in human glial brain tumors. Comparison of immunohistochemistry with in situ hybridization using molecular probes. *J Neurosurg* 1995;83:291-7.
- Lejeune F, Lienard D, Eggermont A, Koops HS, Kroon B, Gerain J, Rosenkainer F, Schmitz P. Clinical experience with high-dose tumor necrosis factor alpha in regional therapy of advanced melanoma. *Circ Shock* 1994;43:191-7.
- Hermann SM, Ricard S, Nicaud V, Mallet C, Arveiler D, Evans A, Ruidavets JB, Luc G, Bara L, Parra HJ, Poirier O, Cambien F. Polymorphisms of the tumor necrosis factor- α gene, coronary heart disease and obesity. *Eur J Clin Invest* 1998;28:59-66.
- Hammann A, Mantzoros C, Vidal-Puig A, Flier JS. Genetic variability in the TNF α promoter is not associated with type II diabetes mellitus (NIDDM). *Biochem Biophys Res Commun* 1995;211:833-9.
- Ugliarolo AM, Turbay D, Pesavento PA, Delgado JC, McKenzie FE, Gribben JG, Hartl D, Yunis EJ, Goldfeld AE. Identification of three new single nucleotide polymorphisms in the human tumor necrosis factor- α gene promoter. *Tissue Antigens* 1998;52:359-67.
- Wilson AG, Symons JA, McDowell TL, McDevitt HO, Duff GW. Effects of a polymorphism in the human tumor necrosis factor α promoter on transcriptional activation. *Proc Natl Acad Sci USA* 1997;94:3195-9.
- Chouchane L, Ben Ahmed S, Baccouche S, Remadi S. Polymorphism in the tumor necrosis factor- α promoter region and in the heat shock protein 70 genes associated with malignant tumors. *Cancer* 1997;80:1489-96.
- Pociot F, D'Alfonso S, Compasso S, Scorza R, Richiardi PM. Functional analysis of a new polymorphism in the human TNF alpha gene promoter. *Scand J Immunol* 1995;42:501-4.
- Höhler T, Kruger A, Gerken G, Schneider PM, Meyer zum Büschenfelde KH, Rittner C. Tumor necrosis factor alpha promoter polymorphism at position -238 is associated with chronic active hepatitis C infection. *J Med Virol* 1998;54:173-7.
- McGuire W, Knight JC, Hill AV, Allsopp CE, Greenwood BM, Kwiatkowski D. Severe malarial anemia and cerebral malaria are associated with different tumor necrosis factor promoter alleles. *J Infect Dis* 1999;179:287-90.
- Zheng MH, Wood DJ, Papadimitriou JM. What's new in the role of cytokines on osteoblast proliferation and differentiation? *Path Res Pract* 1992;188:1104-21.
- Jia SF, Kleiner ES. Antitumor activity of TNF α , IL-1 and IFN γ against three human osteosarcoma cell lines. *Lymphokine Cytokine Res* 1991;10:281-4.
- Van Valen F, Winkelmann W, Burdach S, Göbel U, Jürgens H. Interferon γ and tumor necrosis factor α induce a synergistic antiproliferative response in Ewing's sarcoma cells in vitro. *J Cancer Res Clin Oncol* 1993;119:615-21.
- Sambrook J, Fritsch EF, Maniatis T. *Molecular cloning: a laboratory manual*. Cold Spring Harbor, NY: Cold Spring Harbor Laboratory Press, 1989.
- Patiño-García A, Sotillo-Piñeiro E, Modesto C, Sierrasesúмага L. Screening of the tumor necrosis factor- α (TNF α) gene promoter polymorphisms by PCR-DGGE analysis. *Mutat Res Genomics* 1999;406:121-5.
- Wilson AG, di Giovane FS, Blakemore AF, Duff GW. Single base polymorphism in the human tumor necrosis factor alpha (TNF α) gene detectable by NcoI restriction of PCR product. *Hum Mol Genet* 1992;1:353.
- Verjans GM, Brinkmann BNM, Van Doornik CEM, Kijlstra A, Verweij CL. Polymorphism of tumor necrosis factor- α (TNF α) at position -308 in relation with ankylosing spondylitis. *Clin Exp Immunol* 1994;97:45-7.
- Demeter J, Porzolt F, Rámisch S, Schmidt D, Schmid M, Messer G. Polymorphism of the tumor necrosis factor- α and lymphotoxin- α genes in chronic lymphocytic leukaemia. *Br J Haematol* 1997;97:107-12.
- D'Alfonso S, Richiardi PM. A polymorphic variation in a putative regulation box of the TNF α promoter region. *Immunogenetics* 1994;39:150-4.
- Pfeiffer A, Janott J, Möhlig M, Ristow M, Rochlitz H, Busch K, Schatz H, Schifferdecker E. Circulating tumor necrosis factor- α is elevated in male but not in female patients with type II diabetes mellitus. *Horm Metab Res* 1997;29:111-14.

Low prevalence of germline *BRCA1* mutations in early onset breast cancer without a family history

EDITOR— Germline mutations in the *BRCA1* and *BRCA2* genes cause predisposition to breast and ovarian cancer.¹ Epidemiological evidence and linkage studies suggested that the likelihood that a woman with breast cancer has a genetic susceptibility to the condition is greater the younger she was at diagnosis and with increasing extent of family history of the disease. Studies of the prevalence of germline mutations in *BRCA1* and *BRCA2* in women with breast cancer has enabled the frequency of mutations to be determined in women with different ages at diagnosis and extent of family history of breast cancer.^{2,3} The CASH study into the attributable risk of breast and ovarian cancer estimated that 33% of all breast cancers diagnosed by the age of 29 years, and 22% diagnosed by the age of 30-39 years, are the result of an inherited mutation.⁴ However, the proportion of breast cancer cases diagnosed by 40 years resulting from a *BRCA1* mutation was predicted to be 5.3%.⁵ Previous population based studies of the prevalence of *BRCA1* mutations in early onset breast cancer have been in cases unselected for family history, and the majority of mutation carriers detected did have some degree of family history of either breast or ovarian cancer.⁶⁻¹⁰ The aim of this study was to establish the prevalence of *BRCA1* mutations in a large series of British patients with a young age of onset and no known family history of the disease, since such patients are referred relatively frequently for genetic counselling. The presence of *BRCA1* mutations in a significant proportion of these patients would have important implications for the planning of a mutation screening strategy in diagnostic services.

Patients were ascertained from the Imperial Cancer Research Fund Clinical Breast Oncology Department at Guy's Hospital, and the family cancer clinics at the Genetics Departments of Guy's Hospital and the Royal Free Hospital, both in London, and from St Mary's Hospital, Manchester. The Manchester cases were initially ascertained as part of a population based series for other studies. Patients without a known family history of breast or ovarian cancer at referral were recruited into this study, and these patients were interviewed at home by a genetic nurse counsellor. A family history was taken by the clinical geneticist or genetic nurse counsellor, and the diagnosis confirmed in all probands with either the referring breast unit or the patient's GP or oncologist. Patients with a known family history of breast or ovarian cancer at referral were excluded from the study. The range of age of diagnosis was 22-35 years and the median age of diagnosis was 31 years. Blood samples were taken after the purpose of the study had been explained and informed consent obtained. Full genetic counselling was provided, following agreed protocols, and results were made available to those women wishing to be informed.

The 22 *BRCA1* coding exons were amplified using 24 pairs of primers (exon 11 was amplified in three overlapping fragments). The fluorescent chemical cleavage of mismatch (FCCM) protocol was adapted from the method of Rowley *et al.*¹¹ PCR products were labelled by incorporation of dUTP analogues which were labelled with either R110 (blue), R6G (green), or Tamra (yellow)

fluorescent dyes (PE Applied Biosystems Inc), and heteroduplex molecules then subjected to hydroxylamine modification and piperidine cleavage. Using the three different dyes to label the 24 PCR products that cover the complete *BRCA1* coding sequence, three patients could be analysed for one fragment in one lane of the gel; thus three patients were completely screened in 24 lanes and six patients were screened on a 50 well gel. The FCCM technique has been reported to detect over 95% of mutations in a blind study of haemophilia A patients.¹¹ We evaluated the sensitivity of our *BRCA1* protocol by examination of the eight polymorphisms that have been reported in the *BRCA1* gene with a frequency of at least 5% (1186A/G, 2201C/T, 2430T/C, 2731C/T, 3232A/G, 3667A/G, 4427C/T, 4956A/G).¹² These polymorphisms were all detected reproducibly at the expected frequency in a panel of over 400 patients who were tested, as part of our continuing studies. In addition, FCCM detected the mutations in three known *BRCA1* positive samples (188del 11bp, 5242 C/A, and 5382insC) that were previously found in our laboratory by SSCP analysis.¹³ The fluorescent chemical cleavage assay which we have developed therefore allows a rapid and sensitive mutation screen of *BRCA1*.

Four mutations that were likely to be pathogenic were detected in 110 patients (3.6%) and are listed in table 1. These included three sequence variants that would be predicted to result in premature termination of translation. The 185delAG frameshift mutation, which is prevalent in the Ashkenazi Jewish population, was identified in a British patient (91032) with Jewish ancestry. The 4693-4694delAA mutation was detected in a British patient (78750) who was diagnosed with breast cancer at the age of 26 years. The truncating mutation 3875-3878delGTCT was seen in a patient of Afro-Caribbean origin (94641), who was diagnosed with breast cancer aged 33 years and with a second primary cancer at 38 years. Testing for this mutation in the parents of the patient indicated that it was inherited from her father. A novel in frame deletion, 1965-1967delTCT, was detected in a patient of West African origin (103727) who was diagnosed with breast cancer at the age of 27 years. This mutation would be predicted to result in the deletion of a single amino acid, serine 616, but would not lead to premature termination of translation. This sequence change was absent in over 350 control chromosomes in our study and fulfils all the other criteria for pathogenic status.¹³ The pedigrees of these four women are shown in fig 1. Although all four patients originally reported no family history of breast cancer, further investigation showed that the maternal great grandmother of patient 103727 was diagnosed with the disease at about 60 years of age. The lack of a history of breast or ovarian cancer in these families is likely to result from a combination of factors including paternal transmission of the mutation, chance, and reduced penetrance.

Eight other rare DNA sequence variants were identified (table 2). Three of these would not be predicted to alter the expression of *BRCA1* or the sequence of its encoded protein (Q1604Q, IVS22+8T/C, UGA+36T/C) and R1347G

Table 1 *BRCA1* pathogenic mutations

Patient	Exon	Nucleotide change	Amino acid change
91032	2	185-186delAG	39 stop
103727	11	1965-1967delTCT	S616del
94641	11	3875-3878delGTCT	1264 stop
78750	15	4693-4694delAA	1529 stop

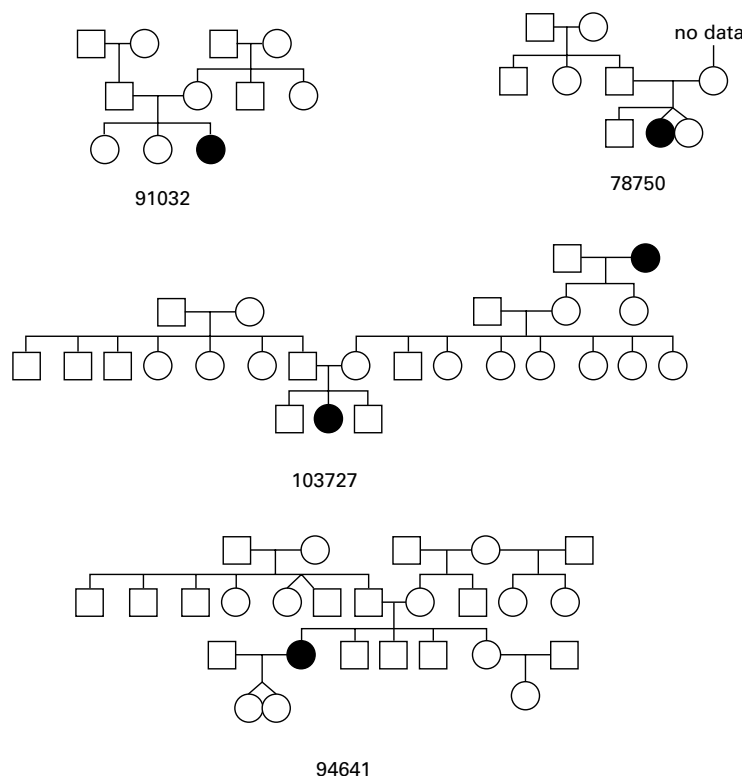

Figure 1 Pedigrees of cases in whom a pathogenic *BRCA1* mutation was identified.

Table 2 *BRCA1* unclassified variants and polymorphisms

Exon	Nucleotide change	Amino acid change	Freq in controls	Conserved in mouse/dog	BIC entries
11	2531 G/C	Q804H	0.0	+/-	0
11	3537 A/G	S1140G	0.0	-/+	15
11	4158 A/G	R1347G	0.01*	-/+	75
16	4931 A/G	Q1604Q	ND	+/+†	16
16	5029 C/T	P1637L	0.0	+/+	11
18	5075 G/A	M1652I	0.01	+/+	8
intron 22	IVS22+8 T/C	Unknown	ND	ND	2
3' untrans	UGA+36 C/G	Unknown	ND	ND	4

*As reported by Langston *et al.*⁷

†Nucleotide sequence is conserved in mouse and dog *BRCA1* genes.

ND = not determined.

was present in a patient with a frameshift mutation.¹² The pathogenic status of the other four (Q804H, S1140G, P1637L, and M1652I) remains inconclusive in the absence of a functional assay for the *BRCA1* protein. At present, screening panels of ethnically matched controls is a useful means of excluding missense mutations as pathogenic mutations of high penetrance, and it would be helpful if this information was provided in the Breast Cancer database (www.nhgri.nih.gov/Intramural_research/Lab_transfer/Bic/index.html).

Our detection of pathogenic *BRCA1* mutations in 3.6% of young breast cancer patients without a family history of breast or ovarian cancer is consistent with the estimate of Ford *et al.*⁶ that the proportion of breast cancer cases in the general population resulting from *BRCA1* is 5.3% below the age of 40 years. A recent population based study of young British breast cancer patients unselected for family history found *BRCA1* mutations in nine of 254 (3.5%) women diagnosed by the age of 36 years.⁸ In North American studies of *BRCA1* mutations in women unselected for family history and diagnosed below the age of 35 years, Langston *et al.*⁷ detected mutations in 7.5%, Malone *et al.*⁹ in 6.2%, and Struewing *et al.*¹⁰ in 5.7%. Fitzgerald *et al.*⁶ detected *BRCA1* mutations in 13% of women diagnosed before the age of 30 years, but this included Ashkenazi

Jewish patients who have founder mutations and some patients with a family history. Since we did not screen the promoter region of *BRCA1* or for deletions of entire exons,¹⁴ we cannot exclude the possibility that some mutations were missed, and the pathogenic status of several sequence variants remains unresolved. However, the important practical implication of our study is that, given the time and expense involved, it would be reasonable to attach a low priority to *BRCA1* mutation screening of young isolated cases of breast cancer in the context of the provision of a publicly funded and cost effective diagnostic service. A screen of this cohort of patients for *BRCA2* mutations is in progress.

This study was supported by the NHS National Cancer Research and Development Programme (UK) (project No NCP/B11/34).

DAVID ELLIS*
 JILL GREENMAN*
 SHIRLEY HODGSON*
 SAM McCALL*
 FIONA LALLOO†
 JUNE CAMERON*
 LOUISE IZATT*
 GILLIAN SCOTT*
 CHRIS JACOBS*
 SALLY WATTS*
 WENDY CHORLEY‡
 CHRIS PERRETT‡

KAY MACDERMOT§
SHEHLA MOHAMMED*
GARETH EVANS†
CHRISTOPHER G MATHEW*

*Division of Medical and Molecular Genetics, GKT School of Medicine,
8th Floor, Guy's Tower, Guy's Hospital, London SE1 9RT, UK

†Department of Medical Genetics, St. Mary's Hospital, Hathersage Road,
Manchester M13 0JH, UK

‡Department of Obstetrics and Gynaecology, Royal Free Hospital, Pond
Street, London NW3 2PF, UK

§Department of Clinical Genetics, Royal Free Hospital, Pond Street,
London NW3 2PF, UK

Correspondence to: Professor Mathew, christopher.mathew@kcl.ac.uk

- 1 Rahman N, Stratton MR. The genetics of breast cancer susceptibility. *Annu Rev Genet* 1998;32:95-121.
- 2 Stratton MR. Recent advances in understanding of genetic susceptibility to breast cancer. *Hum Mol Genet* 1996;5:1515-19.
- 3 Neuhausen SL, Ostrander EA. Mutation testing of early-onset breast cancer genes *BRCA1* and *BRCA2*. *Genet Test* 1997;1:75-82.
- 4 Claus EB, Schildkraut JM, Thompson WD, Risch NJ. The genetic attributable risk of breast and ovarian cancer. *Cancer* 1996;77:2318-24.
- 5 Ford D, Easton DF, Peto J. Estimates of the gene frequency of *BRCA1* and its contribution to breast and ovarian cancer incidence. *Am J Hum Genet* 1995;57:1457-62.
- 6 Fitzgerald MG, MacDonald DJ, Krainer M, Hoover I, O'Neil E, Unsal H, Silva-Arrieto S, Finkelstein DM, Beer-Romero P, Englert C, Sgroi DC,

- Smith BL, Younger JW, Garber JE, Duda RB, Mayzel KA, Isselbacher KJ, Friend SH, Haber DA. Germline *BRCA1* mutations in Jewish and non-Jewish women with early-onset breast cancer. *N Engl J Med* 1996;334:143-9.
- 7 Langston AA, Malone KE, Thompson JD, Daling JR, Ostrander EA. *BRCA1* mutations in a population-based sample of young women with breast cancer. *N Engl J Med* 1996;334:136.
- 8 Peto J, Collins N, Barfoot R, Seal S, Warren W, Rahman N, Easton DF, Evans C, Deacon J, Stratton MR. Prevalence of *BRCA1* and *BRCA2* gene mutations in patients with early-onset breast cancer. *J Natl Cancer Inst* 1999;91:943-9.
- 9 Malone KE, Daling JR, Thompson JD, O'Brien CA, Francisco LV, Ostrander EA. *BRCA1* mutations and breast cancer in the general population. Analyses in women before age 35 years and in women before age 45 years with first-degree family history. *JAMA* 1998;279:922-9.
- 10 Struwing JP, Tarone RE, Brody LC, Li FP, Boice JD. *BRCA1* mutations in young women with breast cancer. *Lancet* 1996;347:1493.
- 11 Rowley G, Saad S, Gianelli F, Green P. Ultrarapid mutation detection by multiplex, solid-phase chemical cleavage. *Genomics* 1995;30:574-82.
- 12 Durocher F, Shattuck-Eidens D, McClure M, Labrie F, Skolnick MH, Goldgar DE, Simard J. Comparison of *BRCA1* polymorphisms, rare sequence variants and/or missense mutations in unaffected and breast/ovarian cancer populations. *Hum Mol Genet* 1996;5:835-42.
- 13 Greenman J, Mohammed S, Ellis D, Watt S, Scott G, Izatt L, Barnes D, Solomon E, Hodgson S, Mathew C. Identification of missense and truncating mutations in the *BRCA1* gene in sporadic and familial breast and ovarian cancer. *Genes Chrom Cancer* 1998;21:244-9.
- 14 Puget N, Stoppa-Lyonnet D, Sinilnikova OM, Pages S, Lynch HT, Lenoir GM, Mazoyer S. Screening for germ-line rearrangements and regulatory mutations in *BRCA1* led to the identification of four new deletions. *Cancer Res* 1999;59:455-61.

J Med Genet 2000;37:794-796

Delineation of a new syndrome: clustering of pyloric stenosis, endometriosis, and breast cancer in two families

EDITOR—Familial tendencies have previously been observed for congenital pyloric stenosis, endometriosis, and breast cancer. These conditions have never been considered to have shared aetiological origins and consequently no previous attempts have been made to investigate an association. For example, when obtaining family history information for a child with pyloric stenosis, one would not routinely request a description of adult onset conditions such as endometriosis or breast cancer. Two families sharing an unusual clustering of these three conditions (pyloric stenosis, endometriosis, and breast cancer) were ascertained at the familial cancer clinics of the Women's College and Princess Margaret Hospitals in Toronto.

Family 1 (fig 1) contains four confirmed cases of breast cancer (below age 60), seven cases of endometriosis, five cases of congenital pyloric stenosis, nine cases of polycystic ovaries, and four cases of non-insulin dependent diabetes. In a second unrelated family, a woman previously diagnosed with premenopausal breast cancer, endometriosis, and pyloric stenosis reported one other case of congenital pyloric stenosis and four other cases of endometriosis in her family (fig 1). It is the similar and unusual presentation in these two families which suggests that the clustering of pyloric stenosis, endometriosis, and breast cancer may not be the result of chance.

A family history of breast cancer is known to be the most significant risk factor for developing the disease. Approximately 5-10% of all cases are hereditary and accounted for by mutations in cancer susceptibility genes *BRCA1* and *BRCA2*.^{1,2} Family 1 met our criteria for *BRCA1* and *BRCA2* testing, with four known cases of breast cancer diagnosed below the age of 60. Mutation analysis by direct sequencing of the coding regions of *BRCA1* and *BRCA2* as well as 1700 adjacent non-coding intronic base pairs was performed by Myriad Genetic Laboratories ([\[www.myriad.com\]\(http://www.myriad.com\)\). No *BRCA* mutation was identified for family 1. Family 2 was not tested for *BRCA1* or *BRCA2* mutations.](http://</p>
</div>
<div data-bbox=)

The aetiology of endometriosis remains uncertain, although familial trends have been described.³ Four studies found that there is an increased risk among first degree relatives.⁴⁻⁷ A small twin study found 6/8 monozygotic and 0/2 dizygotic twin pairs had endometriosis.⁷ In family 2, five women in three generations had endometriosis and in family 1 seven women in three generations were given the diagnosis. The pattern of inheritance is consistent with sex limited, autosomal dominant inheritance.

A multifactorial genetic contribution for pyloric stenosis has been well established, although its pathological basis remains unknown. Twin studies have shown that there is a 25-40% concordance rate in monozygotic twins.^{8,9} Based on pooled data from several family studies and assuming a population prevalence of 0.3%, a relative risk for first degree relatives compared to the general population was 18¹⁰; however, population based studies (unselected patients) have not been done. Pyloric stenosis has recently been linked to the locus of the neuronal nitric oxide synthase (*NOS1*) gene, based on 27 families.¹¹ The *NOS1* locus was also examined for other multifactorial conditions such as asthma (candidate gene)^{13,14} and multiple sclerosis (no association).¹⁵ Family 1 has five documented cases of surgically corrected pyloric stenosis in three males and two females. Family 2 has a parent and child with PS, both female.

In addition to endometriosis, family 1 contains nine women with polycystic ovary syndrome (PCOS), including one woman with non-insulin dependent diabetes mellitus (NIDDM). PCOS and NIDDM have been shown to have a shared aetiology.¹² Women with PCOS have a unique disorder of insulin action and are at increased risk of developing NIDDM, which occurs substantially younger (in the third to fourth decades) than it does in the general population.

Breast cancer, endometriosis, and pyloric stenosis in families 1 and 2 may be explained by separate genetic predispositions; however, the possibility that there is a common genetic basis exists. It is the complex interplay between environmental, hormonal, and genetic factors which poses a challenge to understanding the aetiology of

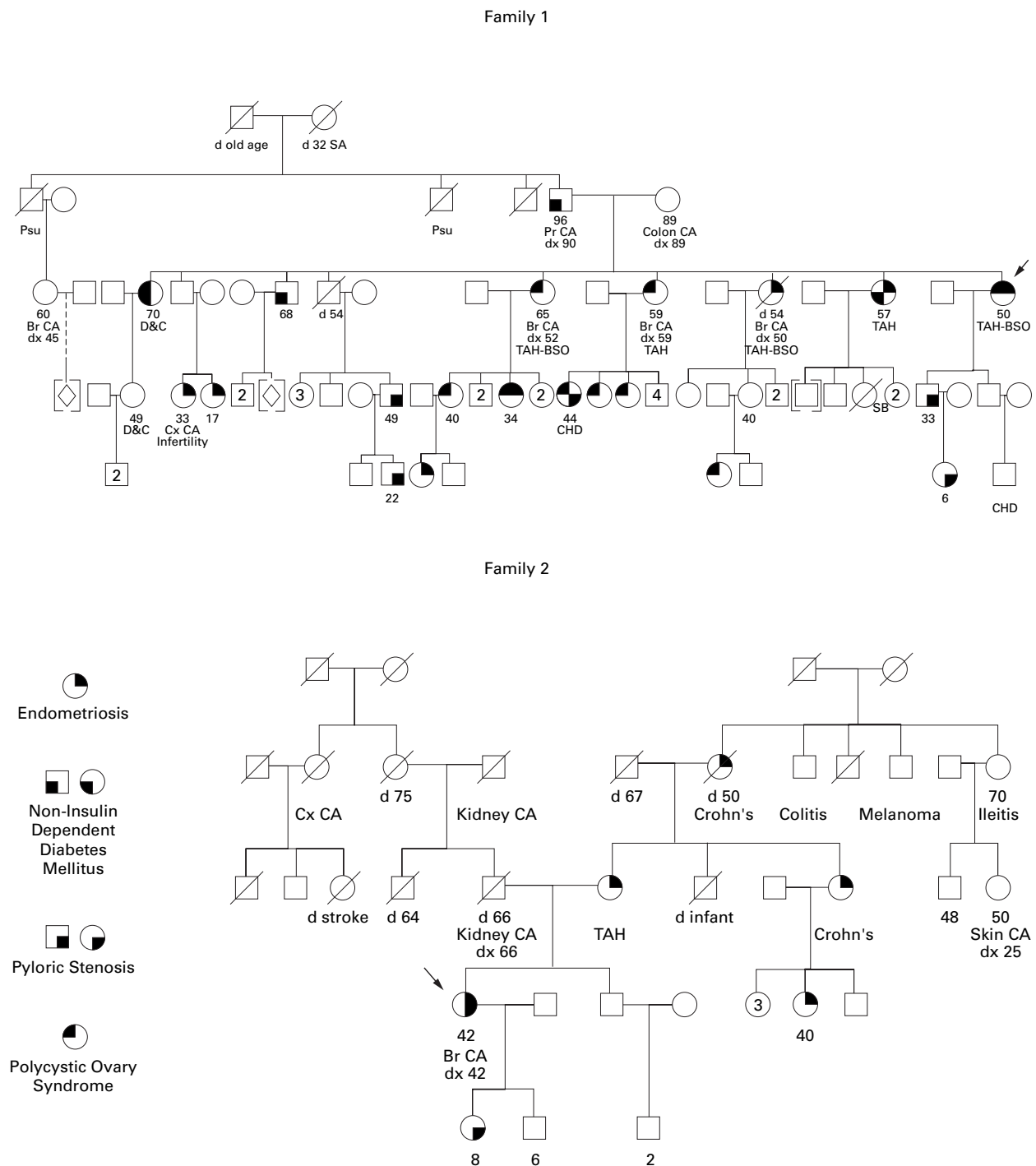

Figure 1 Pedigrees of families 1 and 2. Proband is indicated by an arrow. The age of the subjects appears directly below symbol. CA = breast cancer followed by age of diagnosis (dx); Psu = primary site of cancer was not known; Pr CA = prostate cancer; Cx CA = cervical cancer; TAH = total abdominal hysterectomy; BSO = bilateral salpingo-oophorectomy; NIDDM = non-insulin dependent diabetes mellitus; CHD = congenital heart disease; D&C = dilatation and curettage; SA = spontaneous abortion; SB = stillbirth.

each condition. A future study of pyloric stenosis in a case-control design may investigate any association with breast cancer or endometriosis.

ALEXANDER LIEDE
TUYA PAL
MARGOT MITCHELL
STEVEN A NAROD

Breast Cancer Research, University of Toronto, 790 Bay Street, 750A, Toronto, ON M5G 1N8, Canada

Correspondence to: Professor Narod, steven.narod@swchsc.on.ca

1 Wooster R, Bignell G, Lancaster J. Identification of the breast cancer susceptibility gene BRCA2. *Nature* 1995;378:789-92.

2 Miki Y, Swensen J, Shattuck-Eidens D. A strong candidate for the breast and ovarian cancer susceptibility gene BRCA1. *Science* 1994;266:66-71.

3 Kennedy S, Mardon H, Barlow D. Familial endometriosis. *J Assist Reprod Genet* 1995;12:32-4.

4 Simpson JL, Elias S, Malinak LR, Buttram VC. Heritable aspects of endometriosis. I. Genetic studies. *Am J Obstet Gynecol* 1980;137:327-31.

5 Coxhead D, Thomas EJ. Familial inheritance of endometriosis in a British population. A case control study. *J Obstet Gynaecol* 1993;13:42-4.

6 Moen MH, Magnus P. The familial risk of endometriosis. *Acta Obstet Gynaecol Scand* 1993;73:59-62.

7 Moen MH. Endometriosis in monozygotic twins. *Acta Obstet Gynaecol Scand* 1994;73:59-62.

8 Metrakos JD. Congenital hypertrophic pyloric stenosis in twins. *Arch Dis Child* 1953;27:351-8.

- 9 MacMahon B, McKeown T. Infantile hypertrophic pyloric stenosis: data on 81 pairs of twins. *Acta Genet Med Gemellol* 1955;4:320-5.
- 10 Mitchell LE, Risch N. The genetics of infantile hypertrophic pyloric stenosis: a reanalysis. *Am J Dis Child* 1993;147:1203-11.
- 11 Chung E, Curtis D, Chen G, Marsden PA, Twells R, Xu W, Gardiner M. Genetic evidence for the neuronal nitric oxide synthase gene (NOS1) as a susceptibility locus for infantile pyloric stenosis. *Am J Hum Genet* 1996;58:363-70.
- 12 Dunaif A. Hyperandrogenic anovulation (PCOS): a unique disorder of insulin action associated with an increased risk of non-insulin-dependent diabetes mellitus. *Am J Med* 1995;98:33-9S.
- 13 Grasemann H, Yandava CN, Drazen JM. Neuronal NO synthase (NOS1) is a major candidate gene for asthma. *Clin Exp Allergy* 1999;29(suppl 4):39-41.
- 14 Gao PS, Kawada H, Kasamatsu T, Mao XQ, Roberts MH, Miyamoto Y, Yoshimura M, Saitoh Y, Yasue H, Nakao K, Adra CN, Kun JF, Moro-oka S, Inoko H, Ho LP, Shirakawa T, Hopkin JM. Variants of NOS1, NOS2, and NOS3 genes in asthmatics. *Biochem Biophys Res Commun* 2000;267:761-3.
- 15 Xu C, Hillert J. Absence of linkage with the neuronal nitric oxide synthase (NOS1) gene in 41 multiplex Swedish MS families. *Eur J Neurol* 1998;5:393-6.

J Med Genet 2000;37:796-798

Punctate calcification of the epiphyses, visceral malformations, and craniofacial dysmorphism in a female baby

EDITOR—We report a fetus with striking craniofacial dysmorphism, brachydactyly, and cerebral and cardiac malformations in addition to punctate calcification of the epiphyses.

The mother was treated for tuberculosis seven years before the pregnancy but there were no known systemic illnesses or teratogenic influences during this pregnancy.

The mother's first pregnancy resulted in a termination at 22 weeks of gestation for multiple congenital abnormalities, but further details are not known.

The baby was the second child born to a 21 year old mother. A termination was performed at 21 weeks of gestation because of multiple anomalies seen on antenatal scanning. Necropsy showed a female fetus (fig 1) with a weight of 1544 g, consistent with 17 weeks' gestation. The crown-heel length was 16.4 cm and right foot length was 18 mm. Facial examination showed an open right eye with exophthalmos, hypertelorism, a flat nasal bridge with hypoplasia of the alae nasi, flattening of the midface, a short philtrum with a well defined philtral groove, large lips, and a wide mouth with micrognathia. The right ear was simple and low set and the left ear was rudimentary



Figure 1 (A) Front view of fetus. (B) Hand of fetus. (C) Foot of fetus.

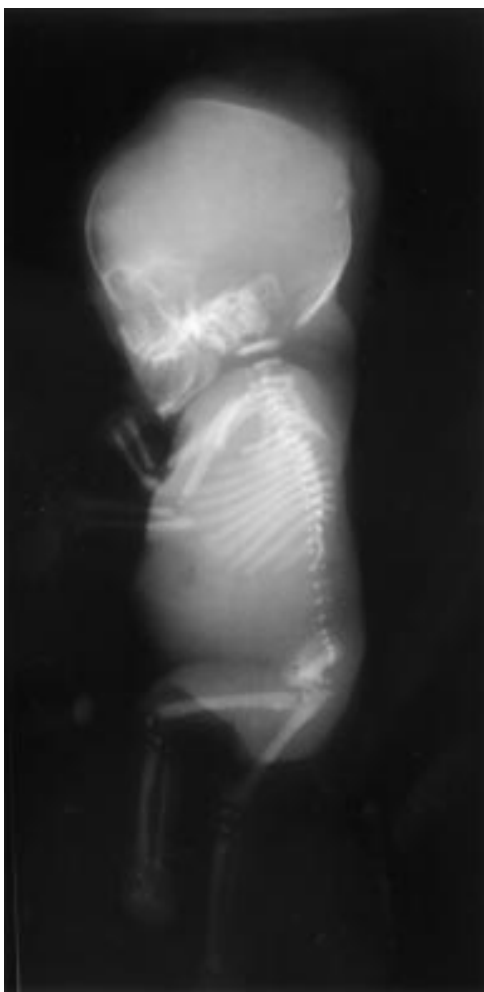

Figure 2 Radiograph of fetus showing punctate calcification of epiphyseal areas and stippling of carpal and tarsal bones.

and poorly formed. The palate was normal. Both hands had brachydactyly involving all digits with short thumbs. There were bilateral varus foot deformities and both feet were rockerbottom in shape. The remainder of the examination showed nuchal thickening, a short, broad chest, and a straight spine. The genitalia were female with a vaginal opening but there was clitoral hypertrophy and prominence of the labial folds.

Internal examination of the brain showed enlargement of both lateral cerebral ventricles, absent olfactory bulbs, and an absent pituitary gland. The heart had a common truncus arising from the right ventricle with a high ventricular septal defect. The right adrenal gland was absent. Histological sections showed that one umbilical artery was rudimentary without a lumen. Examination of the placenta showed no inflammatory changes. Unfortunately, no histological studies were performed on bone.

Chromosome analysis showed an apparently normal female karyotype but the quality of the preparation was sufficient only to exclude numerical and large structural abnormalities. Culture of the fetal cells failed and peroxisomal studies and a 7-dehydrocholesterol level were not performed.

Radiographs (fig 2) showed extensive calcification and stippling in all epiphyseal areas. There was undermodelling of the long bones with shortening of the humeri and relative widening of the diaphyses. There was poor calcification and sagittal clefting of the vertebral bodies. Radiographs of the hands and feet showed stippling in the carpal and tar-

sal bones and the fingers and toes were extremely short with a single phalanx in the second to fifth digits and almost absent ossification of the phalanges. The thorax was short and broad with 11 pairs of ribs and there was posterior dislocation of the hips. The couple chose not to attend genetic counselling clinic.

This baby had an unusual pattern of malformations including right exophthalmos, midface hypoplasia, rudimentary ears, cerebral ventriculomegaly, a common truncus arteriosus and ventricular septal defect, and extreme brachydactyly in addition to calcific stippling of the epiphyses. Epiphyseal stippling can be found in the primary chondrodysplasias,¹ but the visceral abnormalities in this baby are not typical of chondrodysplasia and the presentation is neither consistent with brachytelephalangic chondrodysplasia punctata (CP)^{2,3} or humerometacarpal CP.^{4,5} One plausible diagnosis is Pacman dysplasia, a rare condition in which stippling of the lower spine and epiphyses has been found with bowing of the femora, spinal clefting, and giant, multinucleated, osteoclast-like cells.^{6,7} Although a patent ductus was described in one child, Pacman dysplasia has not been reported with severe visceral abnormalities or craniofacial dysmorphism as found in this baby.

Stippling of the epiphyses is well known to be causally heterogeneous,^{1,8} but syndromes with punctate calcification and visceral malformations are rare. Two sibs were described with short stature, ocular colobomata, midface hypoplasia with a small nose, low set ears, and dysplastic distal phalanges in addition to stippled epiphyses.⁹ A second report of a girl with similar facial dysmorphism, a right retinal coloboma and an incomplete atrioventricular canal, coarctation of the aorta, enlargement of the anterior horns of the lateral ventricles, and partial agenesis of the corpus callosum concluded that these anomalies comprised a separate syndrome.¹⁰ Recently, a male baby with punctate epiphyses and coronal clefting of the spine was described with a Dandy-Walker malformation, hypogenesis of the corpus callosum and falx cerebri, a ventricular septal defect, and bilateral cleft lip and palate.¹¹ This child also had craniofacial dysmorphism with telecanthus, clouding of the corneas, a high nasal bridge and retrognathia, and brachydactyly.

These cases show a degree of similarity to this baby with calcific stippling in association with midface and nasal hypoplasia, dysplastic ears, brachydactyly, and cranial and cerebral malformations. However, the variable nature of the accompanying anomalies makes it difficult to be confident that these patients represent heterogeneity of the same condition. Despite the incomplete clinical information in our case, we believe that documentation of these abnormalities will prove useful in view of the rarity of the combination of features and the paucity of reports describing epiphyseal stippling and malformations.

ANNE SLAVOTINEK
HELEN KINGSTON

University Department of Medical Genetics and Regional Genetic Service, St Mary's Hospital, Hathersage Road, Manchester M13 0JH, UK

Correspondence to: Dr Kingston, helenk@central.cmht.nwest.nhs.uk

- 1 Wulfsberg EA, Curtis J, Jayne CH. Chondrodysplasia punctata: a boy with X-linked recessive chondrodysplasia punctata due to an inherited X-Y translocation with a current classification of these disorders. *Am J Med Genet* 1992;43:823-8.
- 2 Maroteaux P. Brachytelephalangic chondrodysplasia punctata: a possible X-linked recessive form. *Hum Genet* 1989;82:167-70.
- 3 Zizka J, Charvat J, Baxova A, Balicek P, Kozlowski K. Brachytelephalangic chondrodysplasia punctata with distinctive phenotype and normal karyotype. *Am J Med Genet* 1998;76:213-16.
- 4 Borochowitz Z. Generalized chondrodysplasia punctata with shortness of humeri and brachymetacarpus: humero-metacarpal (HM) type: variation or heterogeneity? *Am J Med Genet* 1991;41:417-22.
- 5 Fryburg JS, Kelly TE. Chondrodysplasia punctata, humero-metacarpal type: a second case. *Am J Med Genet* 1996;64:493-6.

- 6 Shohat M, Rimoin DL, Gruber HE, Lachman R. New epiphyseal stippling syndrome with osteoclastic hyperplasia. *Am J Med Genet* 1993;45:558-61.
- 7 Wilcox WR, Lucas BC, Loebel B, Bachman RP, Lachman RS, Rimoin DL. Pacman dysplasia: report of two affected sibs. *Am J Med Genet* 1998;77:272-6.
- 8 Bennett CP, Berry AC, Maxwell DJ, Seller MJ. Chondrodysplasia punctata: another possible X-linked recessive case. *Am J Med Genet* 1992;44:795-9.
- 9 Toriello HV, Higgins JV, Miller T. Provisionally unique autosomal recessive chondrodysplasia punctata syndrome. *Am J Med Genet* 1998;77:272-6.
- 10 Ciske DJ, Waggoner DJ, Downton SB. Unique cardiac and cerebral anomalies with chondrodysplasia punctata. *Am J Med Genet* 1993;47:797-9.
- 11 Mortier GR, Messiaen LM, Espeel M, Smets KJ, Vazieleghem BD, Roels F, De Paepe AM. Chondrodysplasia punctata with multiple congenital anomalies: a new syndrome? *Pediatr Radiol* 1998;28:790-3.

J Med Genet 2000;37:798-804

Unexpected high frequency of de novo unbalanced translocations in patients with Wolf-Hirschhorn syndrome (WHS)

EDITOR—Wolf-Hirschhorn syndrome (WHS), first described independently in 1965 by Wolf *et al*¹ and Hirschhorn *et al*,² is a well defined multiple congenital anomalies/mental retardation syndrome resulting from deletion involving chromosomal band 4p16.3 with a minimal critical region of 165 kb.³

Different mechanisms are responsible for WHS, including terminal 4p deletions, familial translocations, and de novo complex chromosomal rearrangements such as unbalanced translocations. The frequency of translocations in WHS as a result of parental chromosomal translocations is estimated to be 5 to 13%,⁴⁻⁵ whereas the rate of sporadic translocations in WHS was suggested to be 1.6% (2/120).⁵ A few isolated cases with de novo translocations⁵⁻¹² resulting in WHS have been described recently. The trisomic segment, however, often could not be defined owing to the lack of specific cytogenetic techniques.^{5,6,8,13-15}

Here we report six patients with unbalanced translocations, t(4p;8p) and t(4p;7p), respectively, and discuss their phenotypic abnormalities.

Since 1996 we have performed clinical, molecular, cytogenetic, and molecular-cytogenetic investigations in a

total of 22 patients with clinical signs of Wolf-Hirschhorn syndrome. These patients were all seen by one of the authors. In five of them (22%), the combination of cytogenetic and molecular investigations showed a de novo unbalanced translocation; in a sixth patient the de novo occurrence of the translocation could not be confirmed because no blood sample from the father was available.

The clinical findings of patients 1-5, who all presented with characteristic features of WHS, are summarised in table 1. Patient 6 (CL220585/87E1624) had some additional findings listed in table 1.

The combination of Hirschsprung disease and hydrocephalus was suggestive of CRASH syndrome in patient 6, but SSCP analysis of the *LICAM* gene was normal.

Chromosome studies including GTG banding were performed on peripheral blood lymphocytes according to slightly modified standard techniques.¹⁶

DNA from cosmids pC847.351,¹⁷ L21f12 (D4S180), and L228a7 (D4S81)¹⁸ and inter-Alu PCR products¹⁹ from YAC 877G6, 405D10, 794D12, 225D2, and 435A11 (CEPH) were labelled with digoxigenin using a BRL nick translation kit (Gibco, Life Technologies Inc, Gaithersburg, MD, USA). Labelled cosmid and YAC DNA was separated from unincorporated nucleotides by using 1800 ml Centricon 30 (Amicon Inc, Beverly, MA 01915, USA) filters. FISH was performed as described by Lichter *et al*.²⁰ Labelled cosmid DNA (50 ng) or YAC DNA (100 ng) was mixed with human Cot-1 fraction DNA to suppress repetitive sequences or block non-specific hybridisation. Hybridisation was detected using monoclonal anti-digoxin, anti-mouse IgG FITC conjugate and anti-rabbit IgG FITC conjugate (Sigma Immuno

Table 1 Clinical findings in patients 1-5 with t(4;8) and patient 6 with t(4;7)

	Patient 1 (CG/96E0600)	Patient 2 (DT/92E1657)	Patient 3 (LF/96E0551)	Patient 4 (NR/97E877)	Patient 5 (AS/94E1416)	Patient 6 (CL/87E1624)
<i>Anthropometric data</i>						
Birth (gestational weeks)	39	36	38	40	40	41
Weight (g)	2900 (-1.0 SD)	2120 (-1.2 SD)	1800 (-3.4 SD)	2240 (-3.6 SD)	2200 (-3.7 SD)	2950 (-1.6 SD)
Length (cm)	NR	46 (-0.4 SD)	42 (-2.9 SD)	47 (-3.2 SD)	45 (-4.3 SD)	48 (-2.5 SD)
OFC (cm)	31.5 (-2.4 SD)	30.5 (-1.9 SD)	NR	31.5 (-2.7 SD)	32 (-2.3 SD)	34 (-1.6 SD)
Age at examination (y)	1 ¹ / ₂	3 ⁵ / ₁₂	3 ⁹ / ₁₂	2	5 ¹⁰ / ₁₂	12
Weight (g)	5240 (-3.8 SD)	9060 (-3.2 SD)	NR	NR	NR	29 000 (-2 SD)
Height (cm)	64.2 (-4.4 SD)	89 (-2.7 SD)	84.5 (-6.7 SD)	72 (-5 SD)	91 (-4.4 SD)	133 (-2.4 SD)
OFC (cm)	41.3 (-3.5 SD)	46.5 (-2.2 SD)	44 (-5.0 SD)	42 (-4.6 SD)	46 (-3.5 SD)	54 (mean)
<i>Dysmorphic features</i>						
Hypertelorism	+	+	+	+	+	+
Strabismus	+	-	+	+	+	+
Broad, large mouth	-	+	-	-	+	+
Downturned corners of mouth	+	+	+	+	+	+
Micrognathia	-	+	+	+	+	+
Cleft lip/palate	-	-	+	+	+	-
Dysplastic ears	+	+	+	+	+	+
Preauricular tag	-	-	+	-	-	-
<i>Internal findings</i>						
Heart defect	-	-	ASD	ASD	-	-
Genital anomalies	-	+	NR	-	-	+
<i>Neurological development</i>						
Sitting age (mth)	13	20	60	-	24	36
Walking age (y)	2	3 ⁵ / ₁₂	6 ⁹ / ₁₂	-	5	?
Simple words (y)	2 ⁶ / ₁₂	-	-	-	-	?
Understanding of speech	++	++	(+)	-	-	++
Seizures	-	+	+	+	+	+
<i>Additional findings</i>						
						Oligohydramnios
						Bilateral pneumothorax
						Flexion contractures of large joints
						Hypoplasia of corpus callosum
						Hirschsprung disease

Chemicals, St Louis, USA) and counterstained using propidium iodide or DAPI.

A cosmid derived from D4S96, the 8p telomere probe and 7p distal probe (Oncor, Gaithersburg, VA, USA) and the whole chromosome paints 4 and 8 (AGS, Heidelberg, Germany/Oncor, Gaithersburg, VA, USA) were hybridised according to the manufacturer's instructions. For the hybridisations, clone pGXba11/340²¹ was used as centromeric control for human chromosome 4.

Genomic DNA was prepared from peripheral blood lymphocytes or EBV transformed lymphoblastoid cell lines from patients and their parents according to previously described techniques.^{22, 23}

Genotyping of chromosome 4p was performed using the following previously described microsatellite markers: D4S1182 (Acc ID GDB 197239²⁴), D4S43 (Acc ID GDB 124360²⁴), ADRA2C (Acc ID GDB 370834²⁵), HOX7 (Acc ID GDB 156991^{26, 27}), D4S403 (Acc ID GDB 188106²⁸), D4S2366 (Acc ID GDB 684453), D4S2639 (Acc ID GDB 685881), and D4S2397 (Acc ID GDB 683982). A new microsatellite, 75B9Rep, was generated by one of the authors based on sequence information of cosmid 75B9A (Acc No Z69651) which is derived from the distal end of the Huntington's disease cosmid contig.²⁹ Oli-

gomers were designed from sequences flanking the compound dinucleotide repeat (CT)₂G(CT)₂₆(CA)₁₄. The following primer sequences were used for the amplification of the repeat, forward primer 5' CTGAACCTTATC-CAATTAGTCTTG 3' and reverse primer 5' GAATCTT-TCTGTCCCACGAT 3'. This primer set amplifies a 227 bp DNA fragment product. PCR reactions were performed in 10 µl volumes containing 100 ng DNA, 0.5 U Genecraft^R Taq polymerase, 1 × Genecraft^R PCR buffer, 2 µmol/l dNTP, 4 pmol/l of each primer, 1 µCi ³²P-dCTP (3000 Ci/mmol/lol, Amersham), and 2 mmol/l MgCl₂. Formamide (2%) was added to increase stringency of the reaction. After an initial denaturation of one minute, 30 cycles of one minute at 94°C, 30 seconds at 57°C, and 30 seconds at 72°C were carried out in a Crocodile III^R (App-lygene) thermocycler. The PCR products were resolved on 6% polyacrylamide gels flanked by a sequence ladder (M13, -40) as size marker. The Hu4/Hu5 (Acc ID GDB 249651) primer pair amplifies the CAG repeat of the huntingtin gene. Primer Hu4 has been published by Riess *et al*²⁵ (primer sequence: Hu4 5' ATGGCGACCT-GGAAAAGCTGATGAA 3'), and primer Hu5 has been published by Rubinsztein *et al*³⁰ (primer sequence: Hu5 5' GGCGGTGGCGGCTGTTGCTGCTGCTGC 3').

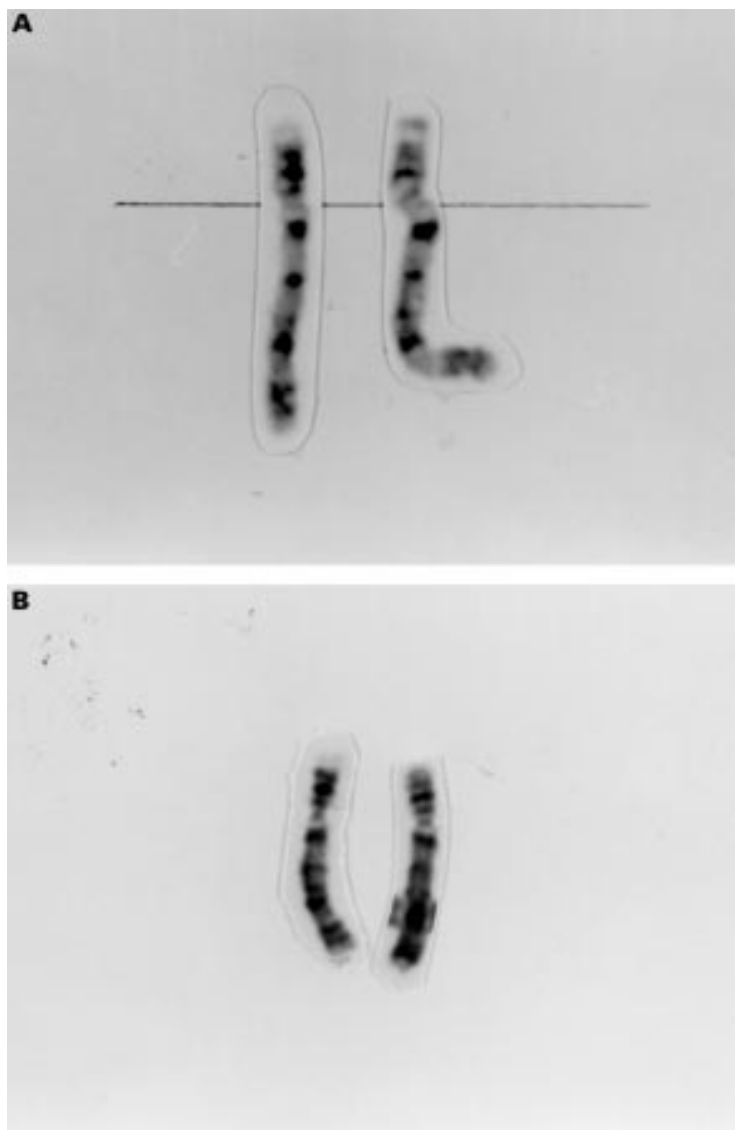

Figure 1 (A) Chromosomes 4 of patient 2 showing an additional G positive band in 4pter. (B) Chromosomes 4 of patient 4 showing same length of 4p but different G banded pattern.

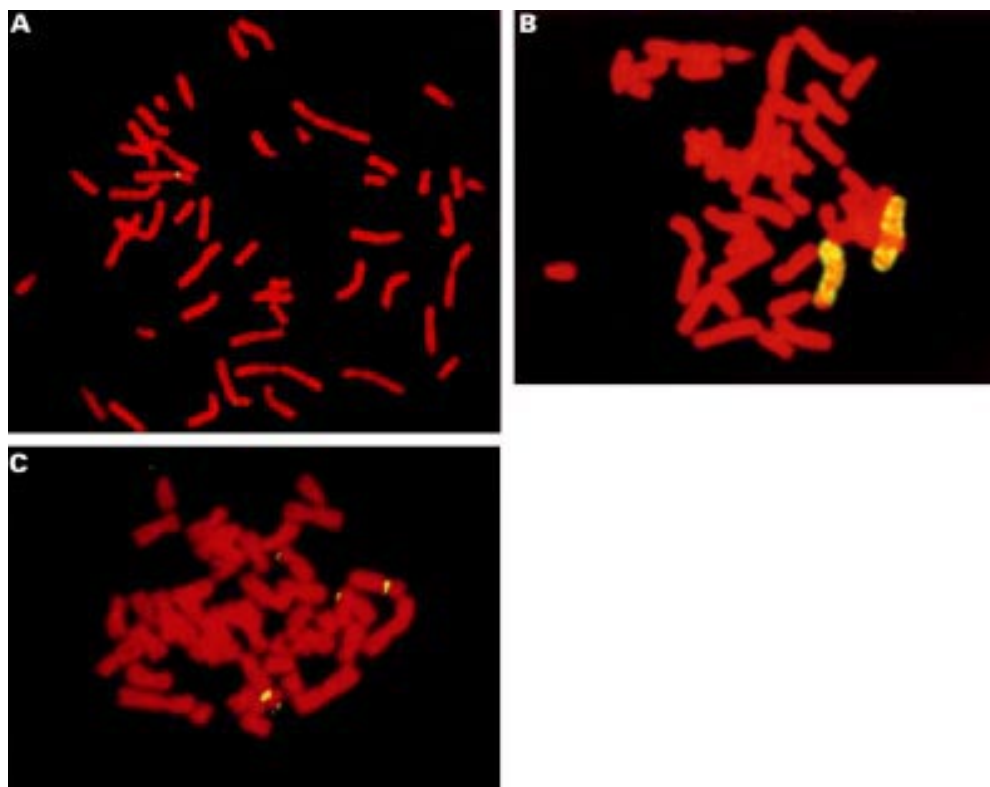

Figure 2 FISH results in patient 4. (A) FISH with cosmid pC847.351 showing lack of signal in one chromosome 4p. (B) FISH with wcp(4) showing fluorescent signals on the entire length of both chromosomes 4 except for the terminal region of one chromosome 4. (C) FISH with distal 8p probe showing two signals in the distal region of 8p and an additional signal in the distal short arm of one chromosome 4.

At the beginning of our study of 22 WHS patients, we reanalysed the chromosomes in lymphocytes by standard Giemsa banding techniques. At a banding resolution of at least 450 bands per haploid genome,³¹ an additional small G positive band was observed on the distal short arm of one chromosome 4 in patients 1 and 2 (fig 1A) and an unbalanced translocation was suspected in patients 3, 4, and 5 (fig 1B). In patient 6, a deletion of 4p with breakpoints in 4p16.2 was suggested. Thus, we suspected an unbalanced translocation between the short arm of one of the chromosomes 4 and another unidentified chromosome in patients 1-5, while the cytogenetic aberration in patient 6 appeared to be a simple deletion.

Chromosomal analysis in all participating parents showed a normal karyotype. In patient 5 the father was not

available. The remaining 16 patients of this study are described elsewhere (D Wiczorek, manuscript in preparation).

Different cosmids were used to confirm the clinical diagnosis of WHS in all patients. In patients 1, 2, and 5, a deletion of D4S96 (Oncor) and of cosmids pC847.351 and L228a7 on one homologue of chromosome 4 was noted (fig 2A). In patients 3 and 4, YAC 405D10 was also deleted on one homologue. In patient 5, the size of the deletion was determined by FISH only. Cosmids pC847.351, L21f12, and L228a7 and YACs 877G6 and 405D10 were deleted on one chromosome 4, whereas YACs 794D12, 225D2, and 435A11 were present on both chromosomes 4 (table 2).

Table 2 Extent and origin of the 4p deletion in patients 1-6

Distance from 4pter	Microsatellite marker	Cosmid	YAC	Patient 1	Patient 2	Patient 3	Patient 4	Patient 5	Patient 6
~ 200 kb		pC847.351 (D4F26)		del	del	del	del	del	del
~ 1.2 Mb		pC678 (D4S96)		del	del	del	del	del	del
~ 1.9 Mb	L75B9 Rep			M	M	M			
~ 2.0 Mb	D4S1182			NI	M	NI			
~ 2.2 Mb	D4S43	33c6 (D4S43)		M	NI	NI			M
~ 3.0 Mb	Hu4/Hu5			M	M	NI			NI
~ 3.3 Mb		L21f12 (D4S180)					del	del	del
~ 3.8 Mb	ADRA2C			NI	M	M			
~ 3.8 Mb		L228a7 (D4S81)		del	del	del	del	del	del
~ 5.5 Mb	Hox7			ND	ND	NI			NI
~ 7.0 Mb			877G6					del	ND
~ 8.8 Mb	D4S2366			ND	ND	M			
~ 13.0 Mb			405D10			del	del	del	ND
~ 14.0 Mb			794D12			ND	ND	ND	ND
~ 16.5 Mb	D4S403			ND	ND	ND			
~ 19.8 Mb			225D2			ND	ND	ND	ND
~ 21.5 Mb			435A11			ND		ND	ND
~ 23.0 Mb	D4S2639			ND	ND	ND			ND
~ 34.0 Mb	D4S2397			ND	ND	ND			ND

del: deleted; ND: not deleted; NI: not informative; M: maternally deleted.

FISH staining with a whole chromosome 4 paint (AGS/Oncor) in all six patients gave hybridisation signals along the entire length of both chromosomes 4 except for the distal part of the aberrant chromosome 4p (fig 2B). Both chromosomes 8 showed hybridisation signals along the entire length with whole chromosome paint 8 (AGS), but also on one chromosome 4 in patients 1-5. FISH with an 8p telomere probe (Oncor, Gaithersburg, VA, USA) showed signals on both chromosomes 8 and an additional signal on one chromosome 4 (fig 2C).

Based on these findings we determined the karyotype of patients 1 and 2 as 46,XX,der(4),t(4;8)(p16.3;p23.1).ish t(4;8)(wcp4-, wcp8+, 8ptel+, pC847.351-, D4S96-, 228a7-; wcp4-, wcp8+, 8ptel+) and in patients 3, 4, and 5 as 46,XX,der(4),t(4;8)(p16.2;p21).ish t(4;8)(wcp4-, wcp8+, 8ptel+, pC847.351-, D4S96-, 228a7-, 405D10-; wcp4-, wcp8+, 8ptel+).

FISH was also performed in the parents of patients 1-4 and the mother of patient 5. Normal results were detected with D4S96 (Oncor) and with the 8p telomere probe (Oncor). We conclude that the translocation t(4;8) occurred de novo in all patients. However, in patient 4 one could not exclude that the translocation may be inherited from the father.

To identify the chromosome involved in the translocation of patient 6, we used different paints and telomeric probes of G negative bands. Additional signals on chromosome 4 were noted with distal 7p probe (Oncor) (fig 3). We determined the karyotype in patient 6 as 46,XY,der(4),t(4;7)(p16;p22).ish t(4;8)(wcp4-, 7ptel+, pC847.351-, D4S96-, 228a7-; wcp4-, 7ptel+). Balanced translocations in his parents were excluded with FISH using D4S96 and 7ptel in combination with pGXba1/340.

The results of the analyses of polymorphic markers are listed in table 2. Blood samples from the father of patient 5 were not available. Therefore, the size of the deletion was determined by FISH only. DNA from patient 4 was not available to identify the origin of the deletion.

In patients 1, 2, 3, and 6, the maternal allele was absent and in patients 4 and 5 the origin of the deletion remains undetermined. In patients 1, 2, and 6, the deletion 4p was at least 3.8 Mb in size and in patients 3-5 the size of the deletion can be estimated to be 13 Mb.

In our study of 22 patients with Wolf-Hirschhorn syndrome, a de novo translocation was present in 5/22 (22.7%) and a familial translocation in 3/22 patients (13.6%) (manuscript in preparation). In one additional

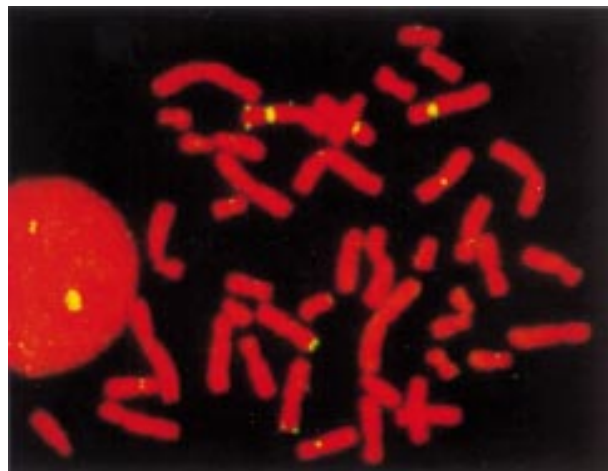

Figure 3 FISH results in patient 6. FISH with distal 7p probe showing two signals in the distal region of 7p and an additional signal in the distal short arm of one chromosome 4.

patient (patient 5) a de novo translocation was suspected, but could not be confirmed. To our knowledge, such a high rate of proven de novo translocations in WHS has not previously been reported. This could be explained by the refined molecular-cytogenetic techniques such as FISH analysis and microsatellite analysis used here. In particular, de novo unbalanced translocations between the short arms of chromosomes 4 and 8 seem to be not uncommon in WHS. Müller-Navia *et al*¹⁰ described one fetus and Petit *et al*^{11, 12} another male patient with this chromosomal aberration.

The breakpoints of 4p and 8p differ in our patients, which makes sequence homologies between these chromosomal segments less likely. Thus, it is of great interest that Kogi *et al*³² and Gondo *et al*³³ described a new class of tandemly repeated satellite DNA elements on chromosome 4p and 8p. They identified a tandem array of several RS447 sequence copies in 4p15 and distal 8p. This repeat was suggested to be responsible for formation of inversion duplication 8p³⁴ and might probably explain the higher frequency of translocations between 4p and 8p.

Moreover, other chromosomes also, for example chromosome 7 in patient 6, occur in de novo unbalanced translocations involving the short arm of chromosome 4. Our findings support the hypothesis of Reid *et al*³⁵ that cryptic complex chromosomal rearrangements are more common than usually disclosed by light microscopy of conventionally stained chromosomes. Selection bias was unlikely, as we investigated blood specimens of all children with known WHS and with a tentative diagnosis of WHS.

Determination of the origin of the deletion showed that in all four patients in whom this was possible the maternal allele was absent, which is in contrast to published data. To avoid bias owing to familial translocations, which are mostly inherited maternally in a 2:1 ratio,³⁶ the patients' parents were also investigated by conventional karyotyping and FISH analysis. We reviewed cases in which the origin of the 4p deletion was determined and found 27 paternally inherited and six maternally inherited deletions.^{7, 15, 37-45} Thus, 82% of reported patients with WHS show a paternally derived deletion.

As to the published patients with maternally inherited deletions, the patient Val described by Anvret *et al*³⁹ had a more complex chromosomal rearrangement causing WHS. Further cytogenetic investigations were not possible. Patients 3 and 6 from the report of Dallapiccola *et al*⁴⁴ and case 2 of Thies *et al*⁴² presented with a de novo, maternally inherited deletion with breakpoints in 4p16.1, 4p16.3, or 4p13, respectively. However, FISH analysis with whole chromosome 4 paint was not performed to exclude a cryptic translocation. In the patient described by Greenberg *et al*,³⁸ cryptic translocation in the mother was discussed, but not investigated. Patient 3 in the report of Kant *et al*³⁷ with maternal origin of the deletion had an unbalanced karyotype based on a cryptic translocation t(4;8) in the mother. Thies *et al*⁴² described a third patient with de novo deletion and also a maternally inherited deletion. On the other hand, in two WHS patients with unidentified de novo translocations⁴⁰ the deletion was of paternal origin.

Different explanations for the preponderance of paternally inherited deletions are possible, for example, statistical deviation or real biological phenomena such as increased mutation rates in sperm or genomic imprinting.⁴¹ An excess of rearrangements in male meiosis, related to differences between the mechanisms of sperm and egg production, have also been discussed.⁴⁴

One aim of our study was to determine whether the WHS phenotype is influenced by the trisomic autosomal segment. The clinical findings in our patients 1-5, in previously published patients with familial translocations

Table 3 Clinical signs of patients with duplication 8p, with unbalanced translocation t(4p;8p), with monosomy 4p, with trisomy 7p, and reported patients

	<i>inv dup 8p*</i>	<i>dir dup 8p†</i>	<i>t(4p;8p)‡</i>	<i>Our patients 1–5</i>	<i>WHS§</i>	<i>Our patient 6</i>	<i>Trisomy 7p¶</i>
Duplicated segment	At least 8p21.1-p21.3	8p22-p23.1 or 8p21.3-p22	8p21-pter – 8p23.1-pter 4p15.3-pter – 4p16.3-pter	8p 4p	7/24	7p	7p11.2-pter
Monosomic segment	8p23.1-pter in 6 cases	none	–	4p	4p14-16	4p	7q36-qter
De novo	14/15	–	0/8	4/5	8/11	+	2/3
Sex	12 F; 8 M	3 F; 3 M	2 F; 6 M	5 F	14 F; 10 M	M	2 M; 1 F
Mental retardation	20/20	5/6	8/8	5/5	22/23	+	3/3
Muscular hypotonia	13/13	0/6	4/4	4/5	20/24	+	2/2
Seizures/EEG anomaly	1/2	0/6	5/8	4/5	18/24	+	NR
Normal birth weight	7/8	4/4	0/6	0/5	0/13	–	2/3
Low birth weight (<3rd centile)	1/17	0/4	6/6	5/5	13/13	+	1/3
Postnatal normal stature	3/6	3/5	0/6	0/5	4/23	–	0/2
Postnatal short stature	2/6	2/5	6/6	5/5	19/23	+	2/2
Absence of dysmorphic signs	10/10	2/3	0/8	0/5	0/23	–	0/3
<i>Craniofacial anomalies</i>							
Microcephaly	3/14	0/6	5/5	5/5	20/24	–	2/3
Macrocephaly	2/14	0/6	0/5	0/5	0/13	–	1/3
Wide open fontanelles	0/1	NR	NR	3/5	NR	+	3/3
Flat occiput	8/13	0/3	1/1	1/2	NR	–	NR
Prominent forehead	13/18	3/6	5/5	5/5	8/11	+	2/3
Prominent glabella	0/5	0/3	4/5	3/5	18/24	–	0/3
Hypertelorism	3/15	1/3	7/7	5/5	20/24	+	3/3
Hypotelorism	3/15	0/3	0/7	0/5	0/13	–	0/3
Strabismus	1/1	0/3	3/4	4/5	13/23	+	NR
Broad nasal bridge	11/17	3/6	6/6	5/5	20/24	+	1/3
Narrow nasal bridge	2/6	0/3	0/6	0/5	0/13	–	1/3
Anteverted nares	7/18	0/3	1/4	0/5	NR	–	2/3
Beaked nose	3/6	0/3	2/6	0/5	6/11	+	1/2
Short philtrum	1/6	1/6	7/7	3/5	13/13	+	1/2
Long philtrum	2/6	0/6	0/7	0/5	0/13	–	2/3
Large mouth	14/19	0/6	4/5	2/5	10/13	+	1/3
Downturned corners of mouth	1/5	0/3	3/4	5/5	13/13	+	1/3
Thin upper lip	9/17	2/6	2/5	4/5	6/13	+	3/3
High arched palate	10/13	0/3	1/3	0/2	2/11	+	NR
Cleft lip/palate	NR	0/3	4/5	3/5	8/24	–	NR
Abnormal dentition	12/13	1/5	3/3	1/1	1/11	–	1/1
Micrognathia	6/8	0/6	6/8	5/5	18/24	+	3/3
Large chin	2/8	1/6	1/5	0/5	0/13	–	1/3
Small ears	0/9	0/3	0/3	0/5	1/11	+	NR
Large ears	8/9	0/3	0/3	0/5	2/11	–	NR
Dysplastic ears	15/18	0/3	6/7	5/5	18/24	+	3/3
<i>Brain anomalies</i>							
Enlarged ventricles	2/6	0/3	1/2	0/2	NR	+	1/1
Agenesis of corpus callosum	4/6	0/3	0/2	0/2	NR	+	NR
Cortical atrophy	2/6	0/3	0/2	0/2	NR	+	NR
Congenital heart defect	5/12	0/6	3/5	2/5	6/24	–	2/3
Scoliosis	6/13	0/3	1/3	0/5	3/13	–	NR
Hypoplastic external genitalia	1/2	0/5	2/2	1/4	3/11	+	2/2
Hypospadias	NR	0/5	5/5	/	7/10	+	0/2
Renal anomalies	1/2	0/3	2/5	1/3	2/11	+	NR
Inguinal/umbilical hernia	3/13	0/3	2/2	0/3	NR	–	NR
Megacolon	NR	0/3	0/2	0/3	NR	+	1/1

*Refs 53–58, 61.

†Refs 60 and 61.

‡Refs 37, 46–51; 10 was not included because of lack of clinical description.

§Refs 6 and 62.

¶Refs 65–67.

t(4;8),^{37 46–52} in patients with partial trisomy 8 owing to inversion duplication^{53–59} or direct duplication,^{60 61} respectively, and in patients with WHS^{6 62} are compared in table 3. There are several clinical signs which are usually present in patients with partial monosomy 4p as well as in those with partial trisomy 8p, such as mental retardation, muscular hypotonia, prominent forehead, broad nasal bridge, large mouth, dysplastic ears, and congenital heart defects. Thus, these features are by no means specific enough to distinguish between the phenotypes.

The face in WHS is much more characteristic than in partial trisomy 8p and is not significantly influenced by the presence of this trisomic segment. All in all, it seems to us impossible to differentiate clinically between patients with WHS resulting from monosomy 4p and WHS resulting from unbalanced translocation 4p;8p. This agrees with the conclusions of other authors.^{37 47–51}

As to patient 6, to our knowledge, no other patient with a de novo translocation t(4p;7p) has been described before.^{63 64} However, many patients with trisomy 7p resulting from familial translocations have been reported. These

patients are not listed in table 3 because a considerable influence on the phenotype by monosomic autosomal segments cannot be excluded. Only those patients with distal duplication 7p are included.^{65–67} The characteristic, clinically recognisable phenotype in trisomy 7p encompasses delayed closure of fontanelles, sparse or even lack of eyebrows, a short nose with a low and broad nasal bridge, small upper and prominent, full lower lip, micrognathia, hypotonia, congenital heart defect, and delayed speech development.⁶⁵ Macrocephaly and enlarged cerebral ventricles were only described in one patient.⁶⁶ One might speculate that relative macrocephaly in patient 6, which is highly unusual in patients with WHS, may be the result of the duplicated segment in 7p. Delicado *et al*⁶⁶ noted intestinal malrotation with dilatation of the sigmoid and left colon in their patient, but excluded Hirschsprung's disease. Our patient presented with similar anomalies of the intestines. We assume that this clinical sign, which has not been described in WHS before, may be caused by the duplication 7p. In conclusion, the overall phenotype in

patient 6, in contrast to patients 1-5, appears to be considerably influenced by the trisomic region of 7p (table 3).

In summary, we show that de novo translocations causing WHS are more frequent than previously estimated. We recommend performing FISH analysis with wcp(4) in every WHS patient to exclude or confirm a de novo translocation as a common mechanism causing WHS. Also patients with cytogenetically visible deletions should be investigated by molecular-cytogenetic techniques to exclude cryptic rearrangements. Moreover, de novo translocations t(4p;8p) in WHS patients are more frequent than previously suspected.

Note added in proof

Since submission of the final version of this paper, 13 patients of this study have been published elsewhere.

We thank Professor Passarge for continuous support and for reading the manuscript, and Professor Horsthemke for helpful discussion. In addition, we thank Barbara Henke, Barbara Ulrich, Elke Jürgens, and Gudrun Rodepeter for excellent technical assistance and the parents for taking part in this study. We thank Dr Herdit Schüller for the results of previous chromosomal analysis in patient 1, Dr A J H Hamers for performing FISH with D4S10 in patient 2, Dr J J M Engelen for FISH in patient 4, and Dr Schröder and Professor A Gal for SSCP analysis of the *L1CAM* gene in patient 6. We also thank Tracy Wright for the cosmid pC847.351, 33c6, 21f12, and 228a7. In addition, we thank CEPH for providing the YACs. DW and GG-K were supported in part by a young investigators grant from the Medical Faculty University of Essen (IFORES 107 402.0) and by the Deutsche Forschungsgemeinschaft (W11440/4-1).

DAGMAR WIECZOREK*
MARIO KRAUSE†
FRANK MAJEWSKI‡
BEATE ALBRECHT*
PETER MEINECKE§
OLAF RIESS¶
GABRIELE GILLESSEN-KAESBACH*

*Institut für Humangenetik, Universitätsklinikum Essen, Germany

†Molekulare Humangenetik, Ruhr-Universität Bochum, Germany

‡Institut für Humangenetik und Anthropologie,

Heinrich-Heine-Universität Düsseldorf, Germany

§Abteilung Medizinische Genetik, Altonaer Kinderkrankenhaus, Hamburg, Germany

¶Abteilung für Medizinische Genetik, Universität Rostock, Germany

Correspondence to: Dr Wieczorek, Institut für Humangenetik, Universitätsklinikum Essen, Hufelandstrasse 55, D-45122 Essen, Germany, dagmar.wieczorek@uni-essen.de

- Wolf U, Reinwein H, Porsch R, Schröter R, Baitsch H. Defizienz an den kurzen Armen eines Chromosoms Nr 4. *Humangenetik* 1965;1:397-413.
- Hirschhorn K, Cooper HL, Firschein LL. Deletion of short arms of chromosome 4-5 in a child with defects of midline fusion. *Humangenetik* 1965;1:479-82.
- Wright TJ, Ricke DO, Denison K, Abmayr S, Cotter PD, Hirschhorn K, Keinänen M, McDonald-McGinn D, Somer M, Spinner N, Yang-Feng T, Zackai E, Altherr MR. A transcript map of the newly defined 165 kb Wolf-Hirschhorn syndrome critical region. *Hum Mol Genet* 1997;6:317-24.
- Centerwall WR, Thompson WP, Irving EA, Fobes CD. Translocation 4p-syndrome. *Am J Dis Child* 1975;129:366-70.
- Lurie IW, Lazjuk GI, Ussova YI, Presman EB, Gurevich DB. The Wolf-Hirschhorn syndrome. I. Genetics. *Clin Genet* 1980;17:375-84.
- Wilson MG, Townner JW, Coffin GS, Ebbin AJ, Siris E, Brager P. Genetic and clinical studies in 13 patients with the Wolf-Hirschhorn syndrome [del(4p)]. *Hum Genet* 1981;59:297-307.
- Gusella JF, Tanzi RE, Bader PI, Phelan MC, Stevenson R, Hayden MR, Hofman KJ, Faryniarz AG, Gibbons K. Deletion of Huntington's disease-linked G8 (D4S10) locus in Wolf-Hirschhorn syndrome. *Nature* 1985;7:75-8.
- Cannizzaro LA, Hecht BK, Bixeman HA, Pazdziorko S, Tamis R, Hecht F. Prenatal diagnosis of a de novo unbalanced translocation (4p+) following in vitro fertilization. *Prenat Diagn* 1988;8:297-301.
- Gandelman KY, Gibson L, Meyn MS, Yang-Feng TL. Molecular definition of the smallest region of deletion overlap in the Wolf-Hirschhorn syndrome. *Am J Hum Genet* 1992;51:571-8.
- Müller-Navia J, Nebel A, Oehler D, Theile U, Zabel B, Schleiermacher E. Microdissection and DOP-PCR-based reverse chromosome painting as a fast and reliable strategy in the analysis of various structural chromosome abnormalities. *Prenat Diagn* 1996;16:915-22.
- Petit P, Schmit J, van den Berghe H, Fryns JP. On two patients with and without the classical Wolf-Hirschhorn syndrome (WHS) sharing the same chromosome 4p16.3 specific probe deletion: evidence of a contiguous gene deletion syndrome. *Clin Genet* 1996;50:19-22.
- Petit P, Vermeersch JR, Fryns JP. Identification of a de novo 46,XY, 4p+ with incomplete Wolf-Hirschhorn syndrome as 46,XY, der(4)t(4;8). *Genet Couns* 1998;9:157-8.
- Rivas F, Hernandez A, Nazara Z, Fragoso R, Olivares N, Rolon A, Cantu JM. On the deletion 4p16 Wolf-Hirschhorn syndrome. *Ann Genet* 1979;22:228-31.
- Ivanov VI, Levina LY, Konstantinova LM, Zayarny AN, Kuleshov NP, Kurov BA. Phenotype and crucial chromosomal segments in partial aneuploids of chromosomal segments in partial aneuploids of chromosome 4 in man. *Genetika* 1990;26:912-24.
- Estabrooks LL, Lamb AN, Aylsworth AS, Callanan P, Rao KW. Molecular characterization of chromosome 4p deletions resulting in Wolf-Hirschhorn syndrome. *J Med Genet* 1994;31:103-7.
- Seabright M. A rapid banding technique for human chromosomes. *Lancet* 1971;2:971-2.
- Altherr MR, Smith B, MacDonald ME, Wasmuth JJ. Isolation of a novel mildly repetitive DNA sequence that is predominantly located at the terminus of the short arm of chromosome 4 near the Huntington disease gene. *Genomics* 1989;5:581-8.
- Riess O, Siedlaczek I, Kredtke S, Melmer G, Epplen JT, Deaven LL. Characterization of a human chromosome 4 flow-sorted cosmid library. *Cytogenet Cell Genet* 1994;65:238-42.
- Lengauer C, Green ED, Cremer T. Fluorescence in situ hybridization of YAC clones after Alu-PCR amplification. *Genomics* 1992;13:826-8.
- Lichter P, Chang CJ, Call K, Hermanson G, Evans GA, Housman D, Ward DC. High resolution mapping of human chromosome 11 by in situ hybridization with cosmid clones. *Science* 1990;247:64-7.
- Hulsebos T, Schonk D, Schepens J, Coerwinkel-Driessen M, van Dalen I, Ropers HH, Wieringa B. Isolation and characterization of repetitive aliphoid sequences specific for the centromeres of chromosomes 4 and 19. *Cytogenet Cell Genet* 1987;46:632.
- Neitzel H. A routine method for the establishment of permanent growing lymphoblastoid cell lines. *Hum Genet* 1986;73:320-6.
- Miller SA, Dykes DD, Polesky HF. A simple salting out procedure for extracting DNA from human nucleated cells. *Nucleic Acids Res* 1988;6:1215.
- Goold RD, diSibio GL, Xu H, Lang DB, Dadgar J, Magrane GG, Duacizyk A, Smith KA, Cox DR, Masters SB, Myers RM. The development of sequence-tagged sites for human chromosome 4. *Hum Mol Genet* 1993;2:1271-88.
- Riess O, Thies U, Siedlaczek I, Potisek S, Graham R, Theilmann J, Grimm T, Epplen JT, Hayden MR. Precise mapping of the brain 2-adrenergic receptor gene within chromosome 4p16. *Genomics* 1994;19:298-302.
- Padanilam BJ, Stadler HS, Mills KA, McLeod LB, Solursh M, Lee B, Ramirez F, Buetow KH, Murray JC. Characterization of the human HOX 7 cDNA and identification of polymorphic markers. *Hum Mol Genet* 1992;1:407-10.
- Cooperative Human Linkage Centre (CHLC). A comprehensive genetic linkage map with centimorgan density. *Science* 1994;265:2049-54.
- Gyapay G, Morissette J, Vignal A, Dib C, Fizames C, Millasseau P, Marc S, Bernardi G, Lathrop M, Weissenbach J. The 1993-94 Genethon human genetic linkage map. *Nat Genet* 1994;7:246-339.
- Baxendale S, MacDonald ME, Mott R, Francis F, Lin C, Kirby SF, James M, Zehetner G, Hummerich H, Valdes J, Collins FS, Deaven LJ, Gusella JF, Lehrach H, Bates GP. A cosmid contig and high resolution restriction map of the 2 megabase region containing the Huntington's disease gene. *Nat Genet* 1993;4:181-6.
- Rubinsztein DC, Barton DE, Davison BC, Ferguson-Smith MA. Analysis of the huntingtin gene reveals a trinucleotide-length polymorphism in the region of the gene that contains two CCG-rich stretches and a correlation between decreased age of onset of Huntington's disease and CAG repeat number. *Hum Mol Genet* 1993;2:1713-15.
- Mitelman F, ed. *ISCN 1995. An international system for human cytogenetic nomenclature*. Basel: S Karger, 1995.
- Kogi M, Fukushige S, Lefevre C, Hadano S, Ikeda JE. Novel tandem repeat sequence located on human chromosome 4p: isolation and characterization. *Genomics* 1997;42:278-83.
- Gondo Y, Okada T, Matsuyama N, Saitoh Y, Yanagisawa Y, Ikeda JE. Human megasatellite DNA RS447: copy-number polymorphisms and interspecies conservation. *Genomics* 1998;54:39-49.
- Nelson TN, Dill FJ, Wood S. A megasatellite repeat may be involved in the formation of inversion duplication 8p. *Am J Hum Genet Suppl* 1998;63:A212.
- Reid E, Morrison N, Barron L, Boyd E, Cooke A, Fielding D, Tolmie JL. Familial Wolf-Hirschhorn syndrome resulting from a cryptic translocation: a clinical and molecular study. *J Med Genet* 1996;33:197-202.
- Nahara K, Himoto Y, Yokoyama Y, Kasai R, Hata A, Kikkawa K, Takahashi Y, Wkita Y, Kimura S, Kimoto H. The critical monosomic segment in 4p-syndrome: a high-resolution banding study on five inherited cases. *Jpn J Hum Genet* 1984;29:403-13.
- Kant SG, Van Haeringen A, Bakker E, Stec I, Donnai D, Mollevanger P, Beverstock GC, Lindeman-Kusse MC, Van Ommen GJB, Pitt-Rogers-Danks syndrome and Wolf-Hirschhorn syndrome are caused by a deletion in the same region on chromosome 4p16.3. *J Med Genet* 1997;34:569-72.
- Greenberg F, Elder FFB, Ledbetter DH, Altherr M, Wasmuth JJ. Molecular confirmation of Wolf-Hirschhorn syndrome with apparently normal chromosomes. *Pediatr Res* 1989;25(suppl):76A.
- Anvret M, Nordenskjöld M, Stolpe L, Johansson L, Bröndum-Nielsen K. Molecular analysis of 4p deletion associated with Wolf-Hirschhorn syndrome moving the "critical segment" towards the telomere. *Hum Genet* 1991;86:481-3.
- Quarrell OWJ, Snell RG, Curtis MA, Roberts SH, Harper PS, Shaw DJ. Paternal origin of the chromosomal deletion resulting in Wolf-Hirschhorn syndrome. *J Med Genet* 1991;28:256-9.
- Altherr MR, Gusella JF, Wasmuth JJ, Kummer MA, McKercher SW, Johnson VP. Molecular detection of a 4p deletion using PCR-based polymorphisms: a technique for the rapid detection of the Wolf-Hirschhorn syndrome. *Am J Med Genet* 1992;44:449-54.
- Thies U, Back E, Wolff G, Schroeder-Kurth T, Hager H-D, Schröder K. Clinical, cytogenetic and molecular investigations in three patients with Wolf-Hirschhorn syndrome. *Clin Genet* 1992;42:201-5.
- Tupler R, Bortotto L, Bühler EM, Alkan M, Malik NJ, Bösch-Al Jadooa N, Memo L, Maraschio P. Paternal origin of the de novo deleted chromosome 4 in Wolf-Hirschhorn syndrome. *J Med Genet* 1992;29:53-5.
- Dallapiccola B, Mandich P, Bellone E, Selicorni A, Mokin V, Ajmar F, Novelli G. Parental origin of chromosome 4p deletion in Wolf-Hirschhorn syndrome. *Am J Med Genet* 1993;47:921-4.
- Dean JCS, Davidson M, Kelly K, Stephen GS. Wolf-Hirschhorn syndrome: paternal origin of a submicroscopic deletion of chromosome 4. *J Med Genet* 1993;30:348.

- 46 Oorthuys JWE, Bleeker-Wagemakers EM. A girl with the Pitt-Rogers-Danks syndrome: further delineation. *Am J Med Genet* 1989;55:420-2.
- 47 Tranebjaerg L, Petersen A, Hove K, Rehder H, Mikkelsen M. Clinical and cytogenetic studies in a large (4;8) translocation family with pre- and post-natal Wolf syndrome. *Ann Genet* 1984;27:224-9.
- 48 Stengel-Rutkowski S, Warkotsch A, Schimanek P, Stene J. Familial Wolf's syndrome with a hidden 4p deletion by translocation of an 8p segment. Unbalanced inheritance from a maternal translocation (4;8)(p15.3;p22). Case report, review and risk estimates. *Clin Genet* 1984;25:500-21.
- 49 Martsolf JT, Chase TR, Jalal SM, Wasdahl WA. Familial transmission of Wolf syndrome resulting from specific deletion 4p16 from t(4;8)(p16;p21)mat. *Clin Genet* 1987;31:366-9.
- 50 Wheeler PG, Weaver DD, Palmer CG. Familial translocation resulting in Wolf-Hirschhorn syndrome in two related unbalanced individuals: clinical evaluation of a 39-year-old man with Wolf-Hirschhorn syndrome. *Am J Med Genet* 1995;55:462-5.
- 51 Partington MW, Fagan K, Soubjaki V, Turner G. Translocation involving 4p16.3 in three families: deletion causing the Pitt-Rogers-Danks syndrome and duplication resulting in a new overgrowth syndrome. *J Med Genet* 1997;34:719-28.
- 52 Bar-El H, Ziv M, Yehudai I, Borochowitz Z, Dar H. Familial translocation t(4;8)(p15;p23) resulting in Wolf-Hirschhorn syndrome: a recurrent non-random rearrangement? *Am J Hum Genet Suppl* 1998;63:712.
- 53 Fryns JP, Kleczkowsky A, Dereymaker AM, Hoefnagels M, Heremans G, Marien J, van den Bergh H. Partial trisomy due to interstitial duplication: karyotype: 46,XX,inv dup(8)(p21.1→p22). *Clin Genet* 1985;28:546-9.
- 54 Dill FJ, Schertzer M, Sandercock J, Tischler B, Wood S. Inverted tandem duplication generates a duplication deficiency of chromosome 8p. *Clin Genet* 1987;32:109-13.
- 55 Kleczkowska A, Fryns JP, D'Hondt F, Jaeken J, van den Berghe H. Partial duplication 8p due to interstitial duplication: inv dup (8)(p21.1→p22). *Ann Genet* 1987;30:47-51.
- 56 Nevin NC, Morrison PJ, Jones J, Mac Reid C. Inverted tandem duplication of 8p12→p23.1 in a child with increased activity of glutathione reductase. *J Med Genet* 1990;27:135-6.
- 57 Gorinati M, Caufin D, Minelli A, Memo L, Gaspario G, Doderio A. Inv dup (8) (p21.1→22.1): further case report and a new hypothesis on the origin of the chromosome abnormality. *Clin Genet* 1991;39:55-9.
- 58 Feldmann GL, Weiss L, Phelan MC, Schroer RJ, Van Dyke DL. Inverted duplication of 8p: ten new patients and review of the literature. *Am J Med Genet* 1993;47:482-6.
- 59 Engelen JJM, de Die-Smulders CEM, Fryns JP, Hoovers JMN, Albrechts JCM, Loots WJG, Jacobs ME, Hamers AJH. Partial trisomy and monosomy 8p due to inversion duplication. *Clin Genet* 1994;45:203-7.
- 60 Dhooze C, Van Roy N, Craic M, Speleman F. Direct transmission of a tandem duplication in the short arm of chromosome 8. *Clin Genet* 1994;45:36-9.
- 61 Engelen JJM, de Die-Smulders CEM, Sijstermans MJM, Meers LEC, Albrechts JCM, Hamers AJH. Familial partial trisomy 8p without dysmorphic features and only mild mental retardation. *J Med Genet* 1995;32:792-5.
- 62 Estabrooks LL, Rao KW, Driscoll DA, Crandall BF, Dean JCS, Ikonen E, Korf B, Aylsworth AS. Preliminary phenotypic map of chromosome 4p16 based on 4p deletions. *Am J Med Genet* 1995;57:581-6.
- 63 *Human cytogenetics database*. Oxford: Oxford University Press, 1994.
- 64 Borgaonkar DS. *Chromosomal variation in man*. 7th ed. New York: Wiley-Liss, 1994.
- 65 Zerres K, Schwanitz G, Gellissen K, Schroers L, Sohler R. Duplication 7p *de novo* and literature review. *Ann Genet* 1989;32:225-9.
- 66 Delicado A, Escibano E, Pajares IL, de Bustamante AD, Carrasco S. A malformed child with a recombinant chromosome 7, rec(7) dup p, derived from a maternal pericentric inversion inv(7)(p15q36). *J Med Genet* 1991;28:126-7.
- 67 Redha MA, Krishna Murty DS, Al-Awadi SA, Al-Sulaiman IS, Sabry MA, El-Bahey SA, Farag TI. *De novo* direct duplication 7p (p11.2→pter) in an arab child with MCA/MR syndrome. Trisomy 7p - a delineated syndrome? *Ann Genet* 1996;39:5-9.
- 68 Wiczorek D, Krause M, Majewski F, Albrecht B, Horn D, Riess O, Gilleßen-Kaesbach G. Effect of the size of the deletion and clinical manifestation in Wolf-Hirschhorn syndrome: analysis of 13 patients with a *de novo* deletion. *Eur J Hum Genet* 2000;8:515-26.

J Med Genet 2000;37:804-806

Mosaicism for a dup(12)(q22q13) in a patient with hypomelanosis of Ito and asymmetry

EDITOR—Hypomelanosis of Ito (HI) (MIM 146150) is an aetiologically heterogeneous physical finding characterised by a swirling pattern of hypopigmentation of the skin, typically distributed along the lines of Blaschko, reflecting pigmentary mosaicism. Chromosomal abnormalities are common and very heterogeneous. They include X;autosomal translocations and mosaicism of aneuploidy, segmental trisomies, or monosomies.¹⁻⁵ As HI is not a specific disorder, it has also been referred to as pigmentary mosaicism.⁶ This report adds a further chromosomal anomaly which has not been described in pigmentary mosaicism previously.



Figure 1 Patient at the age of 10 years.

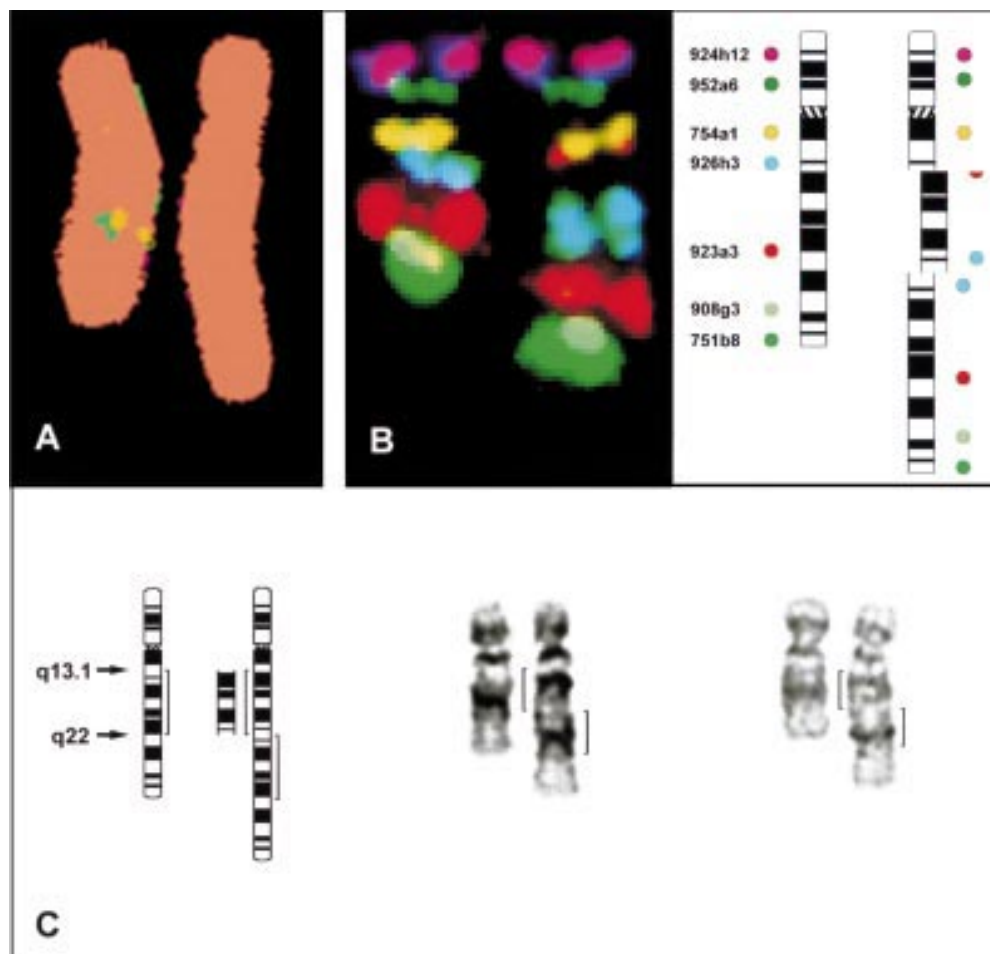

Figure 2 FISH and GTG banding. (A) M-FISH painted the elongated long arm of chromosome 12 homogeneously, indicating a duplication of chromosome 12 material. (B) Application of a multicolour chromosome 12 specific bar code allowed the identification and mapping of the duplicated segment. On the derivative chromosome 12, two signals corresponding to YAC 926h3 (blue) are located close to each other. The 12q21-22 specific YAC 923a3 displayed a weak red signal proximal to the 926h3 double spot in addition to a normal red signal distal to the blue double spot. Thus, the rearrangement represents an inverted duplication of the segment 12q13-q21/22 with upward direction, $\text{dup}(12)(\text{pter-q13}::\text{q22-q13}::\text{q22-qter})$. (C) Breakpoint analysis using GTG banding of chromosome 12, which is in concordance with the results of FISH analysis.

metry, epicanthic folds, a broad nose with a broad nasal tip, retrognathia, dysplastic ears, and a low set posterior hair line were noted (fig 1). Areas of linear hypopigmentation were distributed along the lines of Blaschko and were more evident on the legs. He also showed hemihypertrophy of the right leg, bilateral pes equinovarus, and pectus excavatum. There were no organic defects.

Chromosome analysis of peripheral lymphocytes showed the karyotype $46,XY[91]/46,XY,\text{add}(12q)[9]$. The GTG banding pattern was suggestive of an interstitial duplication involving chromosomal segment q13-q21 or q13-q22 (fig 2). Parental karyotypes were normal. Fibroblast cultures were obtained from a normal and a hypopigmented skin area on the left arm. Fifty cells from each first subculture were analysed and identified 70% abnormal cells in the normal skin and 15% abnormal cells in the hypopigmented skin fibroblast culture. In addition, 2/50 cells from the normally pigmented skin showed the karyotype $46,XY,\text{del}(7)(q31)$.

Multiplex-FISH (M-FISH) allows the identification of chromosomes with distinct colours and was performed as described elsewhere.⁷ The M-FISH analysis showed that the $\text{der}(12)$ consisted of chromosome 12 material only, excluding an interchromosomal rearrangement. No other abnormalities were noted. In order to characterise the $\text{der}(12)$ in more detail a chromosome 12 specific multicolour bar code was constructed with YAC clones from the CEPH library, as previously described⁸ (table 1). On the

$\text{der}(12)$, two signals (blue) were observed for the 12q13 specific YAC 926h3 (fig 2). These signals were located close to each other indicating a duplication of the respective region. The 12q21-22 specific YAC 923a3 displayed a normal signal (red) distal and a weak signal proximal to the 926h3 double spot, indicating that this particular YAC is partially duplicated and spans a breakpoint of the duplication. The multicolour banding pattern clearly showed an inverted duplication involving the segment 12q13-q21/22 and allowed the differentiation between the two possibilities of inverted duplications ($\text{pter-q13}::\text{q22-q13}::\text{q22-qter}$ versus $\text{pter-q21}/22::\text{q22-q13}::\text{q22-qter}$). Using the GTG banding pattern in addition to the FISH results, the structure of the $\text{der}(12)$ could be designated as $\text{dup}(12)(\text{pter-q13}::\text{q22-q13}::\text{q22-qter})$ (fig 2). The patient was thus mosaic for a pure trisomy of the segment 12q13-q21.

Table 1 Barcode set 12-2

YAC	Band	Fluor	Pseudocolour
924h12	p12	Cy3.5, FITC	Lilac
952a6	p11.2-p12	Cy3	Green (dark)
754a1	12q12	Cy5.5	Yellow
926h3	12q13	Cy3.5, Cy3	Blue
923a3	12q21/q22	FITC	Red
908g3	12q24.1-q24.2	Cy5	Green (light)
751b8	12q24.3	Cy3, FITC	Green

In many kinds of de novo chromosomal aberrations, it is impossible to determine the chromosomal origin of the extra material by banding patterns alone and characterisation of the rearrangement often needs FISH analysis with single copy probes. In the present case, a partial trisomy 12q was suspected from the G banding pattern and was confirmed by M-FISH within a single hybridisation experiment. Chromosome specific bar codes obtained from well characterised YAC clones have been shown to be useful for characterising chromosomal rearrangements.⁸ By performing multicolour FISH using a set of chromosome 12 specific YAC clones, the type of duplication in the proband was identified as inverted. Moreover, we could also differentiate between the two possibilities of inverted duplication occurring upwards or downwards on the chromosome arm. Using YAC mapping data and GTG banding pattern analysis, the rearrangement in the proband was defined as an inverted duplication in an upward direction involving the segment 12q13-q22. This case illustrates the potential of multicolour chromosome specific bar codes for the characterisation of intrachromosomal rearrangements by a single hybridisation experiment. Other methods, such as CGH and reverse painting, in general allow the accurate mapping of over-represented regions. However, CGH analysis would have failed in this case because of the mosaicism with a high percentage of normal cells. At best, reverse FISH could only allow the differentiation between direct and the two types of inverted duplication. In contrast, the fortuitous determination of a breakpoint YAC from the bar code enables mapping of the duplication at a molecular level, which would be impossible by CGH or reverse painting.

The trisomy 12q13-q22 was detected in 10% of peripheral lymphocytes, in 70% of fibroblasts obtained from the normally pigmented skin, and in 15% of fibroblasts from the hypopigmented skin. Thus, the proportion of abnormal cells in the two different skin areas did not correlate with the skin pigmentation in the patient. This is not surprising as fibroblasts were investigated and it is expected that melanocytes, as the carriers of the biochemical defect, have a different distribution, because the two cell types have different embryological derivations. As a consequence, the selection of the skin biopsy area should not be guided by the localisation of skin pigmentation abnormality, and biopsy of more than one site may be required to identify the chromosomal anomaly in fibroblasts. A deletion 7q was found in two fibroblast cells of the normally pigmented skin, but not in other cells. We do not know if deletion 7q is the result of a cultural artefact or a third cell line in skin fibroblasts. The low proportion of abnormal lymphocytes shows the importance of analysis of a large number of cells. Moreover, a normal karyotype in lymphocytes of HI patients does not rule out a chromosomal defect, as has been shown for many HI associated chromosomal anomalies, which were detected only in fibroblasts but not in blood cultures.⁹ Like the proband described here, more than 70% of HI patients have one or more abnormalities of the central nervous system, the musculoskeletal system, facies, epidermal structures, and inner organs. The variability of the features associated with HI can be interpreted as a consequence of different chromosomal imbalances. Our proband also showed asymmetrical clinical features, which can also be considered as a non-specific sign of chromosomal mosaicism and as an indication for repeated chromosomal analysis of different tissues, especially if it is associated with mental retardation or dysmorphic features or both.⁹

The proband's phenotype is different from other patients with trisomy of a more distal part of 12q. Trisomy for the segment 12q13-q22 has not been described previously and a characteristic phenotypic pattern cannot be determined. To our knowledge, only three other patients have been reported with an interstitial duplication 12q.¹⁰⁻¹¹ All of them showed mosaicism suggesting that non-mosaic interstitial trisomy 12q may be lethal.

Cytogenetic diagnosis of structural mosaicism enables accurate genetic counselling of families. Given that the parents have normal karyotypes, as in the present family, the recurrence risk is very small. Mosaicism of structural abnormalities with a 46 chromosome complement is rare, and a significant proportion of such cases are direct or inverted duplications.¹² If chimerism were excluded, a postzygotic origin of the rearrangement in a chromosomally normal conceptus can be postulated for intrachromosomal duplications, which would rule out the small risk of parental gonadal mosaicism.

In summary, the present case stresses the importance of careful chromosomal analysis of different tissues in patients with pigmentary anomalies or asymmetrical clinical findings or both, and has shown the usefulness of multicolour FISH with single copy probes resulting in chromosome specific bar codes to characterise intrachromosomal rearrangements.

This study was supported by the Deutsche Forschungsgemeinschaft (Sp 460/3-1) and the Friedrich-Baur-Stiftung.

HEINRICH SCHMIDT*
SABINE UHRIG†
GABY LEDERER‡
JAN MURKEN‡
MICHAEL R SPEICHER†
SIMONE SCHUFFENHAUER‡

*Children's Hospital, Ludwig-Maximilians-University Munich, Goethestrasse 29, D-80336 Munich, Germany

†Institute of Anthropology and Human Genetics, Ludwig-Maximilians-University Munich, Goethestrasse 31, D-80336 Munich, Germany

‡Department of Medical Genetics, Children's Hospital, Ludwig-Maximilians-University Munich, Goethestrasse 29, D-80336 Munich, Germany

Correspondence to: Dr Schuffenhauer, Abteilung Medizinische Genetik, Kinderpoliklinik, Ludwig-Maximilians-Universität München, Goethestrasse 29, D-80336 München, Germany, simone@pedgen.med.uni-muenchen.de

- Ritter CL, Steele MW, Wenger SL, Cohen BA. Chromosome mosaicism in hypomelanosis of Ito. *Am J Med Genet* 1990; **35**:14-17.
- Chitayat D, Friedman JM, Johnston MM. Hypomelanosis of Ito - a non-specific marker of somatic mosaicism: report of case with trisomy 18 mosaicism. *Am J Med Genet* 1990; **35**:422-4.
- Fritz B, Kuster W, Orstavik KH, Naumova A, Spranger J, Rehder H. Pigmentary mosaicism in hypomelanosis of Ito. Further evidence for functional disomy of Xp. *Hum Genet* 1998; **103**:441-9.
- Hatchwell E. Hypomelanosis of Ito and X;autosome translocations: a unifying hypothesis. *J Med Genet* 1996; **33**:177-83.
- Lenzini E, Bertoli P, Artifoni L, Battistella PA, Baccichetti C, Peserico A. Hypomelanosis of Ito: involvement of chromosome aberrations in this syndrome. *Ann Genet* 1991; **34**:30-2.
- Küster W, König A. Hypomelanosis of Ito: no entity, but a cutaneous sign of mosaicism. *Am J Med Genet* 1999; **85**:346-50.
- Eils R, Uhrig S, Saracoglu K, Sätzler K, Bolzer A, Chassery JM, Ganser M, Speicher M. An optimized, fully automated system for fast and accurate identification of chromosomal rearrangements by multiplex-FISH (M-FISH). *Cytogenet Cell Genet* 1998; **82**:160-71.
- Uhrig S, Schuffenhauer S, Fauth C, Wirtz A, Daumer-Haas C, Apacik C, Cohen M, Müller-Navia J, Cremer T, Murken J, Speicher MR. Multiplex-FISH for pre- and postnatal applications. *Am J Hum Genet* 1999; **65**:448-62.
- Woods CG, Bankier A, Curry J, Sheffield LJ, Slaney SF, Smith K, Voullaire L, Wellesley D. Asymmetry and skin pigmentary anomalies in chromosome mosaicism. *J Med Genet* 1994; **31**:694-701.
- Dixon JW, Costa T, Teshima IE. Mosaicism for duplication 12q (12q13→q24.2) in a dysmorphic male infant. *J Med Genet* 1993; **30**:70-2.
- Harrod MJ, Byrne JB, Dev VG, Francke U. Duplication 12q mosaicism in two unrelated patients with a similar syndrome. *Am J Med Genet* 1980; **7**:123-9.
- Gardner RJM, Dockery HE, Fitzgerald PH, Parfitt RG, Romain DR, Scobie N, Shaw RL, Tumewu P, Watt AJ. Mosaicism with a normal cell line an autosomal structural rearrangement. *J Med Genet* 1994; **31**:108-14.

An alphoid supernumerary marker chromosome derived from chromosome 3 ascertained in a fetus with multiple malformations

EDITOR—We report a case in which a termination of pregnancy for fetal abnormality at 18 weeks' gestation showed a supernumerary marker chromosome. This extra chromosome did not hybridise to any alphoid probes and was found to have a chromosome 3 origin when investigated by M-FISH.

An anomaly ultrasound scan was performed because of raised alpha-fetoprotein and beta HCG levels at 17 weeks' gestation in a 32 year old, primigravida mother. The scan showed a large and cystic left kidney, banana sign, and absent cisterna magna, and signs of an open sacral spina bifida. The pregnancy was terminated and necropsy showed a male fetus consistent with 18 weeks' gestation with no dysmorphic facial features. A high arched palate with a small amount of postnuchal oedema was noted as well as a single transverse palmar crease on the right hand. Inspection of the back showed a 1.3 cm long lumbosacral myelomeningocele with protruding lower lumbar spinal cord. On internal examination the cerebral hemispheres were fully cleaved and appeared fluctuant suggesting the possibility of internal hydrocephalus. The posterior fossa of the brain was reduced in anteroposterior diameter as well as appearing deep and funnel shaped, and the extension of the cerebellar tonsils was below the level of the foramen magnum. These findings are consistent with Arnold-Chiari malformation. There was marked asymmetry of the kidneys; the right kidney showed normal fetal lobation and shape but the left kidney was very large and had thin, translucent, subcapsular cysts, especially at the lower pole. The cut surface showed a poor demarcation between the cortex and medulla and the presence of cysts in most of the renal parenchyma. These findings are consistent with cystic renal dysplasia. The placenta was unremarkable and the cord had three normal blood vessels.

The chromosomes of the abortus were examined from fetal skin fibroblasts derived using the method of Fisher *et al.*¹ The metaphases from the fetal fibroblasts and parental blood were GTL banded using a modification of the method of Seabright.² The abortus showed a male karyotype with a metacentric supernumerary marker chromosome approximately the size of a G group chromosome in 17 out of 30 (57%) metaphases examined in primary cultures. In subsequent passaging of the cultures, the proportion of the cells with the marker rapidly diminished. Both parents had apparently normal karyotypes. A fibroblast cell line (DD3329) and lymphoblastoid cell lines (DD3389 father, DD3390 mother) from both parents are available from ECACC, Porton Down, Salisbury, Wilts, SP4 0JG, UK.

Fluorescence in situ hybridisation (FISH) with nick translated biotin or digoxigenin (Boehringer-Mannheim UK) labelled centromere specific alpha satellite probes were used based on a technique by Pinkel *et al.*³ The in situ hybridisation was detected using one layer of FITC conjugated anti-avidin for biotin labelled probes or TRITC conjugated anti-digoxigenin for digoxigenin labelled probes. Diamino-2-phenylindole (DAPI) at the rate of 0.05 mg/ml suspended in an antifade solution (Vectashield, Vector

Labs, UK) was used to counterstain the chromosomes. A Carl Zeiss Axioskop epifluorescent microscope fitted with a Pinkel Fluorescent No 83 filter series (Chroma Technology) was used to examine the hybridisation, while a cooled charged couple device camera captured the images. Smart-capture software (Digital Scientific, Cambridge, UK) was used to analyse and visualise the digitised data. The normal homologues acted as internal controls for the FISH. The marker was screened with a library of alphoid centromere specific probes at $1 \times \text{SSC}$ in 50% formamide stringency, but failed to hybridise to any of the probes, suggesting that what appeared to be the marker's primary constriction did not contain alphoid repeats. This was confirmed when an all centromere alphoid mixture used at low stringency ($2 \times \text{SSC}$ at room temperature) showed strong signal at all centromeres except for the marker (fig 1a).

Multiplex fluorescence in situ hybridisation (M-FISH)⁴ was performed on the marker using the Spectra Vision AssayTM (Vysis). The protocol and probe set was as specified in the SpectraVisionTM Assay protocol. The images were captured on a Provis microscope (Olympus) equipped with a motorised eight position turret with an epifluorescence filter set designed for the fluors used. Analysis was performed using M-FISH software supplied by Perceptive Scientific International Ltd (PSI). Using M-FISH, the marker was identified as being from chromosome 3.

FISH with the 3p and 3q subtelomere probes showed hybridisation to the 3q subtelomere probe on the ends of both arms (fig 1b), and wcp3 hybridised to the whole of the marker (fig 1c). Subsequently CGH^{5,6} was applied using DNA extracted from fetal skin and testis. The CGH profiles were analysed using Vysis Quips CGH software following hybridisations to 10 metaphases from each tissue. The CGH profiles showed a significant gain of material in distal 3q26 in fetal skin and in DNA extracted from testis, a tissue not cultured in vitro. These profiles suggested that the tetrasomy may not include the most distal 3q bands (q28 and q29); however, CGH profiles at the extreme ends of chromosomes are known to be problematic because of variable repeat sequences. Conventional FISH with YAC 919f12 (3q29) confirmed that the marker contained two copies of this sequence (fig 1d). Owing to the instability of the marker in culture, we were unable to perform any investigations with constitutive centromere binding proteins. The conventional cytogenetics was re-evaluated and suggested that the marker was an inverted duplication from chromosome region 3q26.2→qter.

Molecular analysis was undertaken to check for the biparental inheritance of the two normal chromosome 3 homologues and to find the parental origin of the marker chromosome. DNA was extracted from fetal tissue and peripheral blood from the parents. Primer sets were used to detect polymorphic microsatellite repeat sequences along the length of chromosome 3 and it was found that the marker was maternal in origin and that the fetus had inherited one normal chromosome 3 from each of his parents and so excluded uniparental disomy 3.

As far as we are aware, the marker described here is the first instance of an inverted duplication causing tetrasomy for chromosome region 3q26.2→qter. Our patient had a prenatally detected lumbosacral myelomeningocele, Arnold-Chiari malformation with possible hydrocephalus, and cystic renal dysplasia, and as a result was terminated at 18 weeks' gestation. Arnold-Chiari malformation is seen in approximately 1 in 1000 livebirths⁷ and is often associated

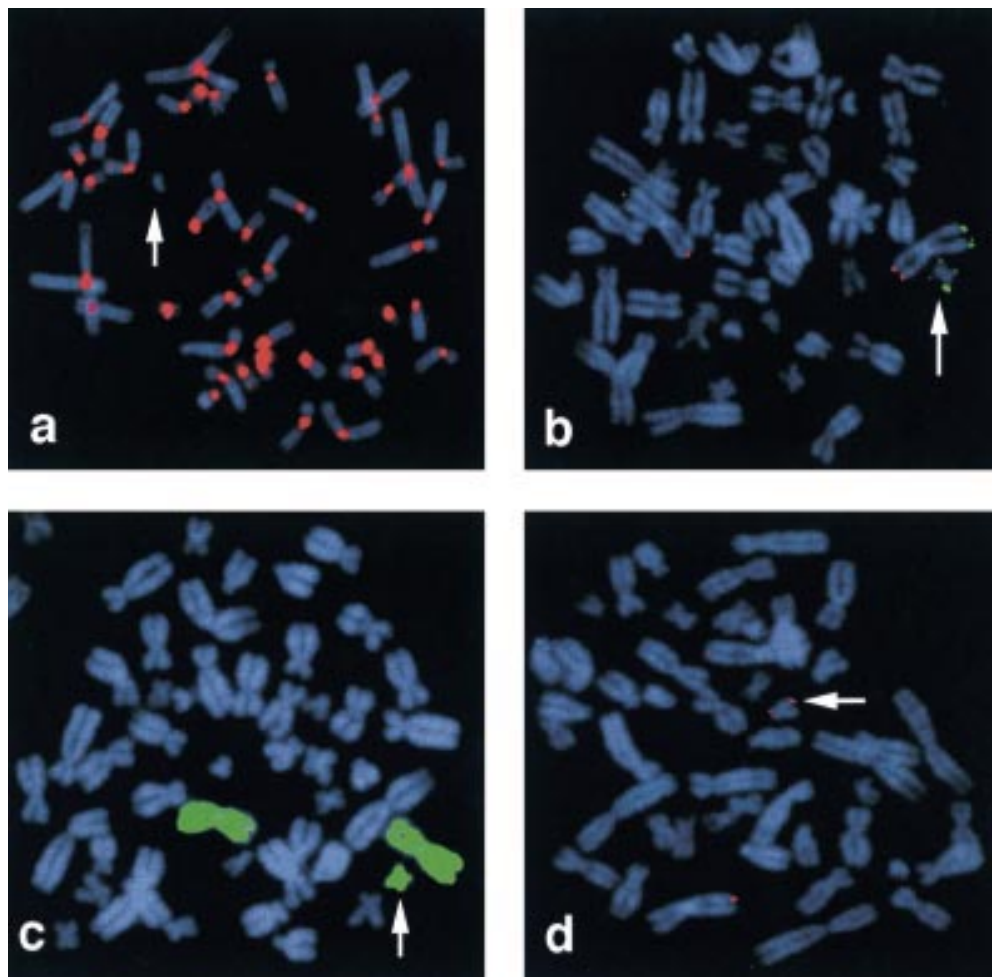

Figure 1 Molecular cytogenetic characterisation of the marker chromosome. Arrow indicates marker chromosome. (a) All centromere alphoid mix. (b) 3q subtelomere probe (196f4) green, 3p subtelomere probe (d711286B18) red. (c) Whole chromosome paint 3. (d) 3q29 probe (YAC 919f12).

with spina bifida with myelomeningocele and hydrocephalus. Schinzel⁸ observed lumbosacral myelomeningocele and Arnold-Chiari malformation in single incidences of dup 3q23→25→q27 to qter. The marker breakpoint is thought to be at 3q26.2, so the marker contains two copies of 3q26.3, which Ireland *et al*⁹ considered to be the location of the Cornelia de Lange syndrome gene and the duplication 3q syndrome critical region.¹⁰ The only features seen which may be associated with de Lange or duplication 3q syndromes, and may also be coincidental, were high arched palate, a transverse crease on the right hand, and left cystic renal aplasia.¹¹ However, our case does prove the need to do a detailed karyotype where upper and mid neural tube defects are associated with other abnormalities.

Portnoi *et al*² reported a similar supernumerary marker chromosome in a healthy 22 year old male of normal intelligence. He was not dysmorphic, but was referred because of skin pigmentary anomalies showing hyperpigmented brown macular streaks following the lines of Blaschko, the onset of which occurred aged 10 to 12 years. The normal skin fibroblasts showed no evidence of the marker, but blood and hyperpigmented fibroblasts showed 30% and 6% cells respectively with the marker. Their marker was alphoid, acrocentric with a breakpoint 3q27.1. The lower level of mosaicism in vivo, proven tissue specificity, and the smaller size of the marker may account for the ameliorated phenotype in this patient compared with our fetus. Another neocentromere located at 3q26 was reported by Wandell *et al*¹³ and was observed in a father and

daughter, ascertained because of developmental delay in the child along with hypertelorism, epicanthus, and a large head. The father had borderline mental retardation. In this case the normal centromeric region was deleted from the chromosome 3 and had formed a small linear marker chromosome. The two distal portions of the deleted 3 had rejoined and a neocentromere was present at 3q26. Interestingly, the neocentromere formed microtubule associated kinetochores of the same size as other large chromosome kinetochores, but was found to be weakly positive with anticentromere (CREST) antibodies, whereas the normal centromere on the small marker chromosome showed a reduced kinetochore size but a strong CREST antibody signal.

Our marker increases the haploid autosomal length of the cell by about 1.5%, but is mosaic (57%) in primary cultures. Other alphoid markers which give rise to tetrasomies of the duplicated regions are also found to be unstable in long term or fibroblasts cultures and are often lost altogether.¹⁴ It seems remarkable that these markers seem to be stable for many cell generations in vivo only to be lost so rapidly in culture. This instability in vitro makes it difficult to judge how much effect our marker had on the phenotype, although we know that it was present in tissues from two different embryonic lineages (fetal skin and testis).

The centromere is an essential structure of the chromosome and chromosomes lacking an active centromere will eventually be lost during subsequent cell divisions. The

centromeric DNA is composed of highly repetitive A+T rich sequences. The most investigated is alpha satellite DNA which in humans is a 171 bp sequence tandemly repeated many times such that between 2 and 4 Mb may be present in a typical centromere.¹⁵ There seems to be no similarity in the primary DNA sequence between species and a lack of centromeric DNA conservation throughout evolution makes it difficult to equate its sequence to function.¹⁶ Nonetheless, the repetitive nature of the DNA and its A+T content appears to be a consistent feature of many organisms and suggests that it is significant in centromere function.¹⁷

Supernumerary marker chromosomes (SMCs) have a prevalence of less than 1 in 1000 in the general population¹⁸ and in recent years in situ hybridisation using alpha satellite probes allows the origin of most of the SMCs to be identified. However, a minority do not hybridise to any of the alphoid probes,¹⁹ but nevertheless these alphoid markers are more or less stable in vivo and in vitro,^{14, 20} suggesting the presence of some centromeric properties, unlike a true acentric chromosome. Two main explanations have been suggested. Firstly, a complex rearrangement has deleted the normal centromere to such an extent that, although it can still function, the highly repetitive alpha satellite probes cannot hybridise to it. Secondly, when the normal centromere was lost, a latent centromere (or neocentromere) was activated in a region not normally associated with centromeric function.^{16, 21, 22} This latter explanation is currently more favoured. Unfortunately, as marker chromosomes tend to be found by chance, only the endpoint is seen, never the intermediate steps nor the mechanism in action by which the neocentromere may be formed.²³

Recent sequencing of the centromeric region of a chromosome 10 derived alphoid marker has shown that compared with the sequence of a normal centromere the marker centromere is lacking in repetitive sequences. The evidence from this neocentromere, and that from the deactivation of centromeres in dicentric chromosomes, is more proof that repetitive sequences per se do not dictate centromere function. In sequencing the chromosome 10 neocentromere, it was found that although the A-T content was no different from that of the rest of the genome, there was evidence of A-T rich islands but the significance of this remains unknown. Nor did the neocentromere sequence differ significantly from the homologous region in the normal chromosome 10 and there was no major feature present similar to known centromeric DNA. The complex rearrangement hypothesis seems unlikely because so much of the material that makes up a normal centromere is missing. So it does seem that a neocentromere forms from a latent centromere activating in a region not known to be centromeric.

Fewer than 35 neocentromeric markers have been reported to date, but they are probably more frequent than this figure suggests because of past difficulties in identification, and it is likely more will be recognised and characterised in the future.¹⁴ Although at least 11 different chromosomes have been implicated in the formation of neocentromeres, it is interesting that our case is the third to be reported in which a neocentromere has been activated in the region near 3q26. Alphoid SMCs have duplicated material from around the centromere, whereas neocentromeric markers will allow us to investigate the effects of duplicated genetic material from other chromosomal regions.

We are grateful to Miss Sarah Beal for excellent technical assistance and we would like to acknowledge Andrew Sharp for the parental origin studies. We wish to thank Dr L Kearney and the National Institutes of Health and Molecular Medicine Collaboration for the subtelomeric probes and also wish to thank the Wellcome Trust for their financial assistance in the purchase of the image enhancement equipment. The CGH profiles were obtained during the "Advanced Molecular Cytogenetics" course held at Cold Spring Harbor Laboratory, March 1999. JAC would like to thank the course tutors, Dr Thomas Ried and Dr Evelin Schröck, for their expert help during the course, and the Wellcome Trust for financial assistance to attend Cold Spring Harbor.

ANNETTE E COCKWELL*
BARBARA GIBBONS†
ISABELLA E MOORE‡
JOHN A CROLLA*

*Wessex Regional Genetics Laboratory, Salisbury District Hospital, Salisbury, Wiltshire SP2 8B7, UK

†NE Thames Regional Cytogenetics Laboratories, 2nd Floor Queen Square House, Institute of Neurology, Queen Square, London WC1N 3BG, UK

‡Histopathology Department, Level E, Southampton General Hospital, Tremona Road, Southampton SO9 4XY, UK

Correspondence to: Dr Cockwell, wessex.genetics@dia1.pipex.com

- Fisher AM, Cockwell AE, Moore KJ, Gregson NM, Campbell PL, Campbell CM, Herbert A, Barber JCK, Crolla JA. Rapid *in situ* harvesting and cytogenetic analysis of perinatal tissue samples. *Prenat Diagn* 1996;16:615-21.
- Seabright M. A rapid banding technique for human chromosomes. *Lancet* 1971;ii:971-2.
- Pinkel D, Landegant J, Collins C, Fusco J, Segraves R, Lucas J, Gray J. Fluorescence *in situ* hybridization with human chromosome-specific libraries: detection of trisomy 21 and translocations of chromosome 4. *Proc Natl Acad Sci USA* 1988;85:9138-42.
- Speicher MR, Ballard SG, Ward DC. Karyotyping human chromosomes by combinatorial multi-fluor FISH. *Nat Genet* 1996;12:368-75.
- Kallioniemi A, Kallioniemi OP, Sudar D, Rutovitz D, Gray JW, Waldman F, Pinkel D. Comparative genomic hybridization for molecular cytogenetic analysis of solid tumours. *Science* 1992;258:818-21.
- Schöck E, Thiel G, Lozanova T, du Manoir S, Meffert MC, Jauch A, Speicher MR, Nürnberg P, Vogel S, Jänisch W, Donis-Keller H, Ried T, Witkowski R, Cremer T. Comparative genomic hybridization of human glioma reveals consistent genetic imbalances and multiple amplification sites. *Am J Pathol* 1994;144:1203-18.
- Moore KL, Persaud TVN. *The developing human, clinically orientated embryology*. 5th ed. Philadelphia: Saunders, 1993.
- Schinzl A. *Catalogue of unbalanced chromosome aberrations in man*. Berlin: Walter de Gruyter, 1983.
- Ireland M, English C, Cross I, Hously WT, Burn J. A de novo translocation t(3;17)(q26.3;q23.1) in a child with Cornelia de Lange syndrome. *J Med Genet* 1991;28:639-40.
- Ireland M, English C, Cross I, Lindsay S, Strachan T. Partial trisomy 3q and the mild Cornelia de Lange syndrome phenotype. *J Med Genet* 1995;32:837-8.
- de Grouchy J, Turleau C. *Clinical atlas of human chromosomes*. 2nd ed. New York: John Wiley, 1984.
- Portnoi MF, Boutchnei S, Bouscarat F, Morlier G, Nizard S, Dersarkissian H, Crickx B, Nouchy M, Taillemite JL, Belaich S. Skin pigmentary anomalies and mosaicism for an acentric marker chromosome originating from 3q. *J Med Genet* 1999;36:246-50.
- Wandell A, Tranebjærg L, Tommerup N. A neocentromere on human chromosome 3 without detectable alpha satellite DNA forms morphologically normal kinetochores. *Chromosoma* 1998;107:359-65.
- Choo KHA. Centromere DNA dynamics: latent centromeres and neocentromere formation. *Am J Hum Genet* 1997;61:1225-33.
- Trowell HE, Nagy A, Vissel B, Choo KHA. Long-range analyses of the centromeric regions of human chromosomes 13, 14 and 21: identification of a narrow domain containing two key centromeric DNA elements. *Hum Mol Genet* 1993;2:1639-49.
- Choo KHA. Turning on the centromere. *Nat Genet* 1998;18:3-4.
- Barry AE, Howman EV, Cancilla MR, Saffery R, Choo KHA. Sequence analysis of an 80 kb human neocentromere. *Hum Mol Genet* 1999;8:217-27.
- Buckton KE, Spowart G, Newton MS, Evans HJ. Forty four probands with an additional "marker" chromosome. *Hum Genet* 1985;69:353-70.
- Crolla JA. FISH and molecular studies of autosomal supernumerary marker chromosomes excluding those derived from chromosome 15. II. A review of the literature. *Am J Med Genet* 1998;75:367-81.
- Depinet TW, Zackowski JL, Earnshaw WC, Kaffe S, Sekhon GS, Stallard R, Sullivan BA, Vance GH, Van Dyke DL, Willard HF, Zinn AB, Schwartz S. Characterization of neo-centromeres in marker chromosomes lacking detectable alpha-satellite DNA. *Hum Mol Genet* 1997;6:1195-204.
- Brown W, Tyler-Smith C. Centromere inactivation. *Trends Genet* 1995;11:337-9.
- du Sart D, Cancilla MR, Earle E, Mao J, Saffery R, Tainton KM, Kalitsis P, Martyn J, Barry AE, Choo KHA. A functional neo-centromere formed through activation of a latent human centromere and consisting of non-alpha-satellite DNA. *Nat Genet* 1997;16:144-53.
- Williams BC, Murphy TD, Goldberg ML, Karpen GH. Neocentromere activity of structurally acentric mini-chromosomes in *Drosophila*. *Nat Genet* 1998;18:30-7.

Why patients do not attend for their appointments at a genetics clinic

EDITOR—When a patient does not attend a scheduled appointment, or cancels so late that a replacement cannot be found, there is a cost to the health care system in terms of personnel time, extended waiting lists, and the loss of potentially beneficial services to patients who miss their visit. These costs are particularly important for genetics clinics because a great deal of preparation is often required before a clinic visit. Preparation may include sending out a family history questionnaire from which a pedigree diagram is constructed, and a review of the medical reports and charts of the patient and other family members. In the case of rare genetic conditions, a preliminary review of publications/computer database search may be conducted and research laboratories may be sought which would be willing to receive patient samples. Furthermore, genetics departments typically set aside at least an hour for each new patient visit.

Failed appointment rates at community and university medical clinics have been reported to range between 10 and 30%.^{1,2} Studies involving hospital clinics set in low socioeconomic status populations have shown no show rates in the upper end of this range, whereas family practice clinics have reported fail rates as low as 5%.³

There is some evidence to suggest that missed appointments may be more likely among certain demographic groups, such as young adults and adults with young children,³ patients with lower socioeconomic and educational status, and those with larger families.¹ Moreover, geographical distance from the clinic or the inability to obtain transport or both have been found to impede appointment keeping.¹ Sex and race have not been associated with compliance.¹

Problems with communicating to patients about the timing or nature of an appointment and in providing them with information about their diagnosis may lead to missed appointments,^{1,4} and a strong recommendation by the referring physician has been shown to have a major benefit on compliance.⁵⁻⁷

There may be a relationship between clinic attendance rates and certain attitudinal factors. There is evidence that patients are more likely to miss their appointments if they perceive the appointment as less urgent^{1,3} or less helpful.⁴ Other potential psychological determinants of health care use are variables from the Health Belief Model (HBM),⁸ including people's perceived risk of developing a particular health condition, perceived severity of the health condition, and the perceived benefits, weighed against the costs, of an associated health behaviour. The HBM has been applied to a variety of health behaviours, such as breast cancer screening practices.^{5,6,9} Patients' beliefs about the personal costs of medical clinic visits have also been shown to affect appointment keeping rates.¹⁰

The Children's Hospital of Eastern Ontario (CHEO) genetics clinic provides diagnostic and counselling services to patients of all ages, including routine advanced maternal age (AMA) counselling, personal or family history of known genetic disease, and the assessment of subjects whose condition is of unknown cause. At a time when clinical demands on our programme are increasing, we became concerned about the negative impact of no shows on our ability to deliver efficient and timely services. On

that basis we undertook a study in order to determine the approximate rates of appointment cancellations and no shows at different Canadian genetics clinics, and to identify factors that may be associated with missing clinic appointments. It was hoped that some associated variables might be amenable to modification and lead to improved attendance rates.

Twenty genetics clinics across Canada responded to a survey regarding the frequency of broken appointments (no shows and cancellations). The centres provide genetic services free of charge as part of their respective provincial health services. The non-attendance rate at the CHEO genetics clinic was also determined. The clinics were separated into three groups according to number of patients seen per year; eight clinics had fewer than 500 patient visits per year (small), eight saw between 500 and 2000 patients per year (medium), and five clinics saw more than 2000 patients per year (large). Representatives of each genetics clinic, usually a medical geneticist or clinic administrator, completed a single page postal questionnaire designed to assess their estimated rates of missed appointments, the extent to which they considered these rates to be a problem, and the strategies they used to reduce non-attendance.

The CHEO genetics clinic operates according to the following pre-appointment procedure. Patients are referred to the clinic by their physician. The clinic receptionist schedules the appointment and, for non-AMA cases, sends the patient a family history questionnaire and consent form for release of medical information. Before the clinic appointment, the patient's case is reviewed with relevant documents and, for non-AMA patients, a family pedigree is drawn. Non-AMA patients are contacted by telephone 24-48 hours before the scheduled visit in order to confirm their attendance (AMA patients do not receive a reminder telephone call). At all stages, patients are asked to cancel if they do not plan to attend their clinic visit.

Data were collected by telephone from two groups of patients originally scheduled for clinic between 1 February 1998 and 30 April 1999: 75 who attended their appointments at the CHEO genetics clinic and 62 who either did not show up for their appointments or who cancelled with less than 12 hours notice. It should be noted that late cancellations (less than 12 hours notice) were counted as no shows because the ensuing consequences were considered to be equivalent. The other surveyed genetics clinics provided separate rates for cancellations in general and for "pure no shows".

A parent was interviewed if the index patient was under 18 years of age. All participants (total n=137) were English or French speaking and lived in the Ottawa-Carleton regional catchment area of approximately 1 million.

Two slightly different versions of the survey instrument were used, one for each group of participants. The instrument was developed by the authors to assess information in four main content areas: (1) demographics (age, marital status, children, education, family income, language spoken at home); (2) referral and genetic service information (reason for referral, the degree to which patients understood these reasons, the quality of explanations provided by referring physicians regarding these reasons, whether or not patients were referred at their own request, and the degree to which referring physicians recommended the genetics appointment); (3) environmental factors (transport, distance from home to the clinic, and arrangements for child care and taking time off work); and

Table 1 Rates of no shows and cancellations at Canadian genetics clinics

	Size of centre*			
	Small (n=8)	Medium (n=8)	Large (n=5)	Total (n=21)
Mean no show rate (%)	9.3	4.7	5.7	6.6
Mean cancellation rate (%)	7.3	5.9	7.0	6.7
Mean combined no show and cancellation rates (%)	15.1	10.0	10.8	12.0
% of centres that indicated non-attendance is a problem	50	75	80	67

*Small = <500 visits/year; medium = 500–2000 visits/year; large = >2000 visits/year.

(4) psychosocial factors (including perceived importance of the clinic visit as well as Health Belief Model variables). A variety of response formats were used, including yes/no, Likert scales, and open ended questions which were later categorised for analysis. The bilingual survey took approximately 15 minutes to complete and was administered by a trained research assistant.

Descriptive statistics were performed to assess the nature of the scheduled appointment at the clinic, as well as the reasons provided by non-attendees for missing their scheduled visit. Attendees and non-attendees were compared on the basis of variables in the four main content areas described above, using independent sample *t* tests and chi-square analyses as appropriate. Two by two factorial analyses of variance were also conducted in order to assess potential interaction effects between group membership and other relevant variables.

Representatives of 27 Canadian genetics clinics were sent copies of the no show survey and 20 (74%) completed and returned the survey. A summary of no show and cancellation rates for the three sizes of clinics is provided in table 1; data from the CHEO genetics clinic are included. Approximately half the data were estimated while the remainder were based on actual records of missed visits. The rate of combined no shows and cancellations at individual centres ranged between 2% and 25%, with an overall mean of 12%. Non-attendance rates were perceived as a problem by most genetics clinics across Canada. However, large and medium centres perceived a greater problem than did smaller centres, despite having lower non-attendance rates (mean rates were 10.8%, 10.0%, and 15.1% for large, medium, and small centres, respectively). If cancellations are eliminated, the mean overall rate of no shows is 6.6%.

For comparison purposes, failed appointment rates were obtained for a variety of other medical clinics at CHEO, including audiology, child development service, neuromuscular medicine, occupational therapy, physiotherapy, rehabilitation medicine, speech/language, and spina bifida clinics. The no show rates for 1998 ranged between 6% and 15%, yielding an overall mean of 11%.

The no show prevention strategies cited by the genetics clinics across Canada were compared. The centres were subdivided by their total non-attendance rate into three groups: low rate (5–11%), medium rate (12–18%), and high rate (19–25%). The impact of the strategy most commonly cited (reminder phone call) could not be assessed because it was used virtually universally. However, the strategy of sending reminder letters to the patient was used most often by centres which reported low non-attendance rates.

A total of 258 households (120 potential attendees and 138 potential non-attendees) were telephoned regarding the study, of which 137 (53%) participated in the survey (75 attendees and 62 non-attendees). Among the subjects/families who did not participate, 24 (20%) could not be reached because of repeated busy signals or answering machines (no messages were left). Another 24 (20%) asked

Table 2 Demographic characteristics of the sample

Variable	Attendees (n=75)		Non-attendees (n=62)	
	No	% of group	No	% of group
Age of respondent				
20–29 years	6	8	9	15
30–34 years	12	16	13	22
35–40 years	43	58	34	56
>40 years	13	18	4	7
Marital status				
Married/common law	65	87	50	81
Single	5	7	7	11
Divorced, separated, or widowed	5	7	5	8
No of children				
0	21	28	10	16
1	24	32	18	29
2–3	27	36	29	47
>3	3	4	5	8
Planning more children*				
Yes	42	56	28	45
No	23	31	31	50
Language spoken at home				
English	48	64	42	68
French	19	25	8	13
Both English and French	3	4	8	13
Other	5	7	4	6
Education†				
Less than high school	4	5	4	7
High school	15	20	20	32
Some college or university	12	16	15	24
College or undergraduate degree	30	40	17	27
Graduate degree	14	19	6	10
Family income‡				
<\$20 000	6	9	4	8
\$20 000–\$40 000	16	25	18	36
\$40 000–\$75 000	19	30	20	40
>\$75 000	23	36	8	16

*Attendees had a higher overall education level than non-attendees, $t(135) = -2.29$, $p < 0.05$.

†Attendees were more likely to be planning more children than non-attendees, $\chi^2(2) = 6.58$, $p < 0.05$.

‡Numbers are smaller for this variable owing to missing data.

the interviewer to phone back at another time, and gave a similar response upon subsequent phone calls, even when the call was made at a prearranged time. Nineteen (17%) of the telephone numbers were either not in service or were wrong numbers, and two of the households (2%) reported that the patient (or parent of the patient) lived elsewhere and did not have a telephone. An additional 12 (10%) subjects had a language barrier. Finally, 30 (25%) of the non-participants stated that they were not interested in doing the survey. There were more no shows (76; 63%) than clinic attendees (45; 37%) among the households that did not participate in the survey.

Table 2 provides a description of participants on the basis of key demographic variables. The average age of respondents was 36 years; where the respondent was a parent of the patient, the average age of patients was 5 years. The large majority of respondents were married/common law (84%) and had children (77%).

Attendees and non-attendees did not differ significantly on the basis of age ($p = 0.21$), marital status ($p = 0.59$), presence of children (yes or no; $p = 0.21$), number of children ($p = 0.09$), language spoken most often at home ($p = 0.11$), or family income ($p = 0.11$). Two demographic variables did yield significant results. Non-attendees had a lower mean level of education than attendees ($p < 0.05$), and patients who were planning to have children (or more children) were more likely to have attended their clinic visits than those who were not planning on starting or expanding their families ($p < 0.05$) (table 3).

Table 3 outlines the main reasons given by non-attendees for missing appointments. The reasons differed significantly between those who were referred for prenatal diagnosis (PND) services and those referred for other reasons ($p < 0.05$). The main reasons given by all

Table 3 Reasons given by non-attendees for missing genetics clinic appointments

Reason given for missing appointment	Reason for referral to genetics			
	PND* (n=31)		Non-PND* (n=31)	
	No	%	No	%
Too busy/no time off work	8	26	14	45
Forgot/scheduling conflict	4	13	7	23
Believed appointment was non-mandatory or unimportant	4	13	1	3
Wanted to wait for lab results	3	10	1	3
Other	1	3	6	19
Unsure/afraid re risks of amniocentesis	4	13	1	3
Recent miscarriage	4	13	0	0
Morning sickness on day of appointment	3	10	1	3

PND = prenatal diagnosis.

*Reasons differed between PND and non-PND patients: $\chi^2(7) = 15.64, p < 0.05$.

non-attendees for missing appointments were being “too busy” or unable to get time off work, forgetting the appointment or having a scheduling conflict, and believing the appointment to be non-mandatory or unimportant. Reasons associated with the PND group included being unsure or afraid of the risks associated with amniocentesis, having recently suffered a miscarriage, experiencing morning sickness on the day of the appointment, and wanting to wait for laboratory test results (such as maternal serum screening) before deciding whether to be seen at the genetics clinic.

Slightly less than half (46%) of all participants were scheduled to meet a medical geneticist at the clinic, and the remainder were scheduled to meet a genetic counsellor. There was no significant difference between attendees and non-attendees with respect to the type of health professional they were scheduled to see at the clinic ($p=0.86$). Approximately half (51%) of all participants were scheduled for appointments associated with advanced maternal age prenatal screening. Another 42 patients (31%) were being seen in order to seek a specific diagnosis; 23 patients (17%) were scheduled to discuss genetic risk information/carrier screening, and only two respondents (1.5%) indicated that they did not know the reason for their referral to the genetics clinic. Attendees and non-attendees did not differ on the basis of their reasons for referral to the clinic ($p=0.46$). Moreover, attendees were no more or less likely than non-attendees to have been referred to the clinic at their own request ($p=0.92$), to understand well the reasons for their referral ($p=0.17$), or to indicate that their physicians had highly recommended the appointment ($p=0.15$) or had explained the reason for referral well ($p=0.13$).

It was hypothesised that some of the referral related variables (table 4) may have been confounded with patients' education level, and so additional analyses were performed in order to separate these effects. A dichotomous version of the education variable (originally in a Likert scale format) was created by cutting scores at the median, yielding the two categories of “high” (at least a college diploma or university undergraduate degree) and “low” (high school education or less). Two by two analyses of variance showed a significant group by education level interaction with regard to patients' reported degree of understanding of the reasons for their referral ($p < 0.05$) and the reported quality of the explanation of these reasons by their referring physicians ($p < 0.05$). An examination of cell means indicated that among patients with a higher education level, attendees understood their reasons for referral better and claimed their physicians had explained these reasons better than did non-attendees. No such

Table 4 Comparison of attendees and non-attendees on referral/genetic service variables

Variable	Attendees (n=75)		Non-attendees (n=62)	
	No	% of group	No	% of group
Reason for referral to genetics				
Prenatal diagnosis	39	52	31	50
Carrier testing/risk information	12	16	11	18
Diagnostic evaluation	24	32	18	29
Other	0	0	2	3
How well was reason explained?*				
Very poorly	0	0	1	2
Poorly	2	3	3	6
Adequately	8	14	10	20
Well	14	25	12	25
Very well	33	58	23	47
How well did you understand the reason?*				
Not at all	0	0	2	3
Poorly	2	3	2	3
Adequately	3	5	4	7
Well	9	15	12	22
Very well	48	77	35	65
Referred at own request				
Yes	26	35	22	36
No	49	65	40	64
How strongly referring physician recommended the genetics appointment?*				
Not strongly	5	8	7	13
Somewhat strongly	20	30	22	40
Quite strongly	15	23	9	16
Very strongly	25	38	16	29
Recommended against	1	1	1	2

*Numbers are smaller for these variables owing to missing data.

group difference existed among patients with a lower education level.

We hypothesised that patients with a higher education level would more likely have been referred to the genetics clinic at their own request, because of their presumed greater knowledge about genetic health services. A chi-square analysis showed this not to be the case ($0.55 < p < 0.60$).

The relationship between non-attendance and environmental variables is shown in table 5. Patients who reported having to arrange for child care in order to attend a clinic visit were more likely to have missed their scheduled appointments than those who indicated no such requirement ($p < 0.05$). Although having to take time off work to attend a clinic visit was not associated with a greater likelihood of non-attendance ($0.70 < p < 0.75$), those respondents who were not paid for such time off were more likely to have missed their appointments than those who were able to take paid leave from work to attend the clinic ($p < 0.05$). No significant differences between attendees and non-attendees were found in methods of transport to the clinic ($0.20 < p < 0.25$) or travel time to the clinic ($0.10 < p < 0.15$). Failure to make contact by telephone to remind the patient of the clinic visit occurred in 10 of the no shows and none of the attendees.

The relationship between non-attendance and psychosocial variables is shown in table 6. Respondents who attended their appointments perceived the clinic visit to be more important than respondents who did not attend ($p < 0.01$). With regard to the Health Belief Model variables, no significant group differences were found in terms of perceived severity of the health condition (or potential health conditions) which were to be discussed during the appointment ($0.65 < p < 0.70$). Moreover, the two groups did not differ significantly with respect to their perceived risk of having (or eventually developing) these health conditions ($0.60 < p < 0.65$).

Non-attendance was significantly related to perceived benefits and disadvantages of the genetics appointment. Specifically, patients who missed their appointments perceived the potential benefits of the clinic visit to be less

Table 5 Comparison of attendees and non-attendees on environmental variables

Variable	Attendees (n=75)		Non-attendees (n=62)	
	No	% of group	No	% of group
Have to arrange for child care to attend the clinic?*				
Yes	12	16	19	31
No	63	84	43	69
Have to take time off work to attend the clinic?				
Yes	39	52	30	49
No	36	48	31	51
If yes, paid for this time off?*				
Yes	23	60	10	33
No	15	40	20	67
Method of transport to clinic				
Own vehicle	65	87	48	77
Get a ride	7	9	6	10
Bus	3	4	6	10
Walk	0	0	2	3
Travel time to clinic				
<15 minutes	4	5	4	7
15–30 minutes	35	47	24	39
30–45 minutes	18	24	10	16
45–60 minutes	7	9	7	11
>60 minutes	11	15	17	27

*p<0.05.

Table 6 Comparison of attendees and non-attendees on psychosocial variables

Variable	Attendees (n=75)		Non-attendees (n=62)	
	No	% of group	No	% of group
Perceived importance of clinic visit*				
Not at all important	1	1	6	10
Of little importance	4	5	5	8
Neutral	8	11	10	16
Somewhat important	16	21	2	3
Very important	46	62	27	43
Perceived severity of genetic condition				
Not at all serious	8	11	11	18
Of little severity	14	19	13	21
Neutral	18	24	5	8
Somewhat serious	12	16	14	23
Very serious	22	30	18	30
Perceived risk of genetic condition				
Very low	16	21	19	32
Somewhat low	13	17	11	18
Medium	26	35	12	20
Somewhat high	11	15	7	12
Very high	9	12	11	18
Perceived benefits of clinic visit*				
No benefits	1	1	7	12
Few benefits	4	5	4	7
Neutral	10	13	10	17
Some benefits	14	19	13	22
Many benefits	46	62	25	42
Perceived importance of disadvantages of clinic visit*				
Not at all important	56	74	30	52
Of little importance	6	8	5	8
Neutral	8	11	8	14
Somewhat important	2	3	3	5
Very important	3	4	12	21

*p<0.01.

important (p<0.01) and the potential disadvantages to be more important (p<0.01) than patients who kept their appointments.

The results of this study help to quantify the problem of missed appointments at genetics clinics across Canada. Over a one year period, approximately 11% of patients scheduled for visits at genetics clinics either cancelled or did not show up for their appointments. When cancellations are eliminated, this number decreases to 6%, representing the rate of “pure no shows”. In comparison, 11% of patients failed to show up for their appointments at other non-genetics outpatient clinics at the Children’s Hospital of Eastern Ontario (CHEO). These values are relatively low compared with the 10–30% range frequently reported.^{1,2} Family practice centres have fewer broken

appointments than adult medical centres.³ Perhaps the family orientation of paediatric and genetics clinics is more akin to family practice and reduces the likelihood that appointments will not be kept.

It should be noted that in the survey of the CHEO genetics clinic, the non-attendees group included cancellations with less than 12 hours notice which, owing to their negative consequences, were considered equivalent to no shows. This distinction between early and late cancellations was not requested from the other genetics clinics surveyed in this study (they were simply asked to report two separate numbers for “pure” no shows and cancellations, respectively). If late cancellations had been included in the no show rates provided by the other clinics, the resulting no show rates would probably have been somewhat higher than reported.

Although an 11% rate of failed appointments at Canadian genetics clinics is comparatively low, it is still a sizeable barrier to the optimal provision of genetic health services. Unlike many clinics, where multiple bookings are common and visits are usually short, genetics clinics expend extensive resources for pre-appointment planning and generally allocate an hour for a clinic visit.

This study suggests a number of factors which may contribute to the problem of missed appointments. The most commonly stated reasons for missed appointments at the CHEO genetics clinic were scheduling conflicts and inability to get time off work. As these are predictable factors, it is surprising that more than half of respondents cited them, despite being called 24–48 hours before the appointment. The question arises as to whether the answers provided by patients over the telephone concealed underlying reasons such as anxiety, confusion, or personal belief systems, which lead to last minute decisions not to attend, or were too personal to admit to the secretary or the research assistant.

Some psychosocial variables appeared to contribute to the non-attendance rate. Patients who attended their scheduled appointments thought their visit to the genetics clinic to be more important than those who did not attend. This is similar to previous research which has found perceived urgency of medical clinic visits to be significantly related to compliance,^{1,3} though urgency and importance may represent relatively distinct constructs.

Patients who attended the clinic also perceived more benefits and fewer barriers associated with their appointments than did non-attendees. This supports the Health Belief Model⁸ and previous research, which has indicated such health beliefs to be important predictors of health behaviours.^{6,9,10} Apparently, for non-attendees, the potential costs of the clinic visit (such as the anxiety or guilt that may be experienced after learning of one’s carrier status) outweighed the possible benefits (such as relief from uncertainty or clarification of one’s options). In contrast, the perception of the benefits of attending the genetics clinic appeared to outweigh the perceived disadvantages for those who kept their appointments.

We found that certain psychosocial factors may play a role in non-attendance, but not all of the anticipated effects were found. For example, perceived severity of the health condition (or potential health condition) for which patients were referred to the clinic, along with the perceived risk of having or eventually facing that health condition, were unrelated to clinic attendance. The former result is not surprising, given that the “perceived severity” component of the Health Belief Model has been shown to have limited value in predicting a variety of health behaviours.¹¹ However, a high perceived risk has been found to predict a number of health behaviours, including mammography,^{5,12} genetic testing for susceptibility to breast cancer,^{13,14} and

cystic fibrosis carrier screening.¹⁵ One possible explanation for the absence of such an effect in this study lies in the nature of the “health condition” in question. Previous research has examined patients’ health beliefs with respect to a single, specific illness or procedure. In the present study, patients were referred to the genetics clinic for a variety of reasons; consequently, a more general question regarding perceived risk was included in the survey which permitted patients to respond according to their own situation. This lack of specificity may have led to a varied interpretation of the question, thus reducing the strength of the “perceived risk” and “perceived severity” variables.

If the above health beliefs are the true reasons that underlie the stated explanations (for example, could not get time off work) given by some patients for missing their appointments, this holds important implications for the provision of adequate public education regarding genetics related health issues. It is widely accepted that a thorough explanation of the risks and benefits associated with a given medical intervention is required in order for patients to provide informed consent. It is not clear how such standards extend to different contexts, such as a genetics clinic appointment. Greater public awareness of the services provided by genetics professionals will provide patients with a balanced and accurate understanding of the importance, risks, and benefits of a scheduled appointment. The fact that patients with a higher education level (at least an undergraduate university degree) were more likely to attend their appointments than those with less education reinforces this need for greater public education. Studies have found that people of lower educational status are more likely to miss their medical appointments.¹ People with a university education probably have greater access to (and experience with) health related information found in scientific journals, books, and news magazines. Delivery of health information to those who have less formal education may facilitate the use of health services by more subjects and families. An alternative interpretation of the education effect is equally possible: those working in higher level positions may simply have greater job flexibility and may thus have had less difficulty attending their clinic appointments.

Other demographic variables, including age, marital status, number of children, language spoken most often at home, and family income, did not differentiate between attendees and non-attendees. This is encouraging, in that most of these variables are not easily targeted by clinic based interventions to improve attendance rates. One exception may be language, which has been subject to limited previous research and is an important variable to assess in a country with two official languages; in our genetics clinic services are regularly provided in French and English. Our finding that language does not appear to be a barrier to attendance is encouraging, but the question may need to be addressed for patients who do not speak either official language. People not fluent in English or French were excluded from the sample. There were 12 people who did not participate in the survey because of a language barrier. Nine of these were in the group who missed their appointments, so this is an issue that may merit further investigation, as a language barrier would represent a potential target for intervention.

It should be noted that the lack of significant results for many demographic variables may be in part because of the narrow response ranges associated with the corresponding survey items. For example, the mean age of survey respondents was quite young (36 years) and people over

the age of 45 were virtually absent from the sample. Studies of adult non-genetics clinics would encompass a wider range of patient ages, leading to a greater likelihood of significant age effects. Moreover, the majority of participants were married (84%) and had children (77%). Only 10 participants (7%) reported a family income of less than \$20 000, indicating a clear under-representation of low socioeconomic status families. The lack of any association with family income may also reflect universal access under the Canadian health care system. Previous studies showing significant effects of socioeconomic status have generally been conducted in the United States, a country which lacks universal health care.

The quality of information given to patients by their referring physicians about the referral to genetics was not associated with the overall rate of missed appointments. However, it did play a role in the specific subgroup of patients with a higher education level. Among those participants, the attendees reported that they understood the reasons for their referral better, and that their physicians had explained these reasons better, than those who did not attend. It appears that while patients with a higher education level are more likely to attend their appointments, they are also more likely to require thorough explanations of the rationale for the appointment before deciding whether or not to attend. Thus there may be some argument for improving the quality of pre-appointment information provided to patients by health care professionals.

These results lend some support to previous research indicating that patients who understand the reasons for their referral relatively well are more likely to attend their clinic appointments.⁴ Contrary to previous studies,^{5,7} however, the degree to which the referring physician recommended the genetics clinic appointment did not influence the likelihood of attendance.

Finally, although difficulties with scheduling conflicts, transport, and inability to take time off work may often at least in part conceal more important underlying reasons for non-attendance, they may sometimes compromise appointment keeping. Patients who had to arrange for child care in order to attend the clinic were more likely to miss their appointments, and this confirms previous results indicating that broken medical appointments are more likely among larger families and those with younger children.^{1,3} The need for child care is an important barrier to the provision of health services at a genetics clinic because families comprise most of the patient population. Provision of day care facilities within medical institutions might prove cost effective, given that all clinics experience a similar, if not higher, no show rate.

The need to take time off work for a clinic appointment does not appear to present a significant barrier to appointment keeping, except for those who are required to take time off without pay. This problem could be solved if clinics extended their hours of operation, so as to accommodate work schedules.

Contrary to previous research,¹ other practical matters such as distance from the clinic and available method of transport were unrelated to rates of failed appointments at the CHEO genetics clinic. Such effects were lacking, despite the fact that patients reported a wide range of travel times, including 28 patients (20%) who indicated that it took them more than an hour to get to the hospital. It may be that once the patient has made an assessment that the appointment is important, travel time may be irrelevant. We cannot draw any conclusions regarding any effects of transport method, because the vast majority (83%) of respondents drove their own vehicles to the clinic. This probably reflects the high mean socioeconomic status of the current sample; studies involving less privileged people

might show that lack of a convenient mode of transport is a significant obstacle in appointment keeping.

Our patient sample does not reflect the general population and is a limitation of the present study. Participants were highly educated and reported relatively high family incomes, which may account for the slightly lower rate of non-attendance at this clinic, as compared with the rates seen in previous studies which have focused mainly on low socioeconomic status populations. It is possible that factors other than those we have evaluated, or that we have found negative in our sample, may contribute to non-attendance rates in patients with a lower educational and socioeconomic status. Nevertheless, our results support some findings of previous studies which included low socioeconomic status populations.^{3 4 10} Moreover, the fact that our non-attendance rate was consistent with those reported by genetics clinics across Canada suggests that these rates reflect an accurate portrayal of the problem in the context of genetics health care in Canada.

Other limitations of this study include the limited generalisability of results to the United States health care system, as well as the telephone interview methodology. For non-attendees in particular, the latter approach may have restricted the degree of candour in participants' survey responses; future studies may benefit from the use of a more anonymous data collection format. Finally, approximately half of the surveyed genetics clinics provided estimated as opposed to actual rates of non-attendance. Estimation may not accurately reflect no show rates; however, a comparison of means indicated that the actual and estimated numbers were similar.

Results of this study suggest a number of potential targets for improving attendance rates at genetics and other outpatient medical clinics. Better education of patients about their medical condition, the nature and purpose of specific options available to them, and the costs and benefits associated with such options, is clearly indicated. To be maximally effective, such education should come from a variety of sources, including the mass media, pamphlets distributed to pharmacies and medical clinics of all types, and, most importantly, open and detailed communication between patients and physicians. Some clinics could also attempt to extend or modify their hours of operation and on site child care initiatives could be explored. These larger scale approaches, in combination with more traditional methods such as telephone and mailed appointment reminders, may help to replace lengthy waiting lists and wasted physician time with more efficient and far reaching health care services.

Support for this project was provided by the Children's Hospital of Eastern Ontario (CHEO) Research Institute. We thank the Canadian genetics centres for their contribution to data collection in the first phase of this study. We also thank Heather Tindell and Laura Van Houten for their role in collecting data at CHEO, as well as the participants for their time and cooperation.

L HUMPHREYS*
A G W HUNTER†
A ZIMAK†
A O'BRIEN*
Y KORNELUK*
M CAPPELLI*

*Mental Health Program, Children's Hospital of Eastern Ontario, 401 Smyth Road, Ottawa, Ontario, Canada K1H 8L1

†Genetics Program, Children's Hospital of Eastern Ontario, Ottawa, Ontario, Canada

Correspondence to: Dr Cappelli, cappelli@cheo.on.ca

- 1 Barron WM. Failed appointments: who misses them, why they are missed, and what can be done. *Primary Care* 1980;7:563-73.
- 2 Deyo RA, Inui TS. Dropouts and broken appointments. *Med Care* 1980;18:1146-57.
- 3 Oppenheim GL, Bergman JJ, English EC. Failed appointments: a review. *J Family Pract* 1979;8:789-96.
- 4 Blankson ML, Goldenberg RL, Keith B. Noncompliance of high-risk pregnant women in keeping appointments at an obstetric complications clinic. *Southern Med J* 1994;87:634-8.
- 5 Aiken LS, West SG, Woodward CK, Reno RR. Health beliefs and compliance with mammography: screening recommendations in asymptomatic women. *Health Psychol* 1994;13:122-9.
- 6 Fulton JP, Buechner JS, Scott HD, DeBuono BA, Feldman JP, Smith RA, Kovenock D. A study guided by the Health Belief Model of the predictors of breast cancer screening of women ages 40 and older. *Public Health Rep* 1991;106:410-19.
- 7 Lerman C, Rimer B, Trock B, Balshem A, Engstrom PF. Factors associated with repeat adherence to breast cancer screening. *Prev Med* 1990;19:279-90.
- 8 Rosenstock IM. The Health Belief Model and preventive health behavior. *Health Educ Monogr* 1974;2:354-86.
- 9 Yeomans-Kinney C, Vernon SW, Frankowski RF, Weber DM, Bitsura JM, Vogel VG. Factors related to enrollment in the breast cancer prevention trial at a comprehensive cancer center during the first year of recruitment. *Cancer* 1995;76:46-56.
- 10 Mirotnik J, Ginzler E, Zagon G, Baptiste A. Using the Health Belief Model to explain clinic appointment-keeping for the management of a chronic disease condition. *J Commun Health* 1998;23:195-209.
- 11 Janz NZ, Becker MH. The Health Belief Model: a decade later. *Health Educ Quart* 1984;11:1-47.
- 12 Calnan M. The Health Belief Model and participation in programmes for the early detection of breast cancer: a comparative analysis. *Soc Sci Med* 1984;19:823-30.
- 13 Chaliki H, Loader S, Levenkron JC. Women's receptivity to testing for a genetic susceptibility to breast cancer. *Am J Public Health* 1995;85:1133-5.
- 14 Lerman C, Daly M, Balshem A. Attitudes about genetic testing for breast-ovarian cancer susceptibility. *J Clin Oncol* 1994;12:843-50.
- 15 Tambor ES, Bernhardt BA, Chase GA. Offering cystic fibrosis carrier screening to an HMO population: factors associated with utilization. *Am J Hum Genet* 1994;55:626-37.

CORRECTION

In the April 2000 issue of the journal, in the paper by Mortier *et al* on "Report of five novel and one recurrent *COL2A1* mutations with analysis of genotype-phenotype correlation in patients with a lethal type II collagen disorder", the mutation T1191N should have been T1190N throughout.